

Migrating PanelView Standard Applications to PanelView Plus 7

Topic	Page
About This Publication	1
Summary of Changes	1
Where to Start	3
Preface	5
Things to Know Before You Migrate	7
Select a Terminal Replacement	13
Import Your Application	43
Review the Application Conversion Log	49
Review Object Mapping	57
Review Unsupported Features	61
Qualify the Runtime Application	65
Create the Runtime Application	75
Optimize Runtime Performance	87
Advanced Object Editing	113
Index	125
Additional Resources	127

About This Publication

This publication provides information to help you convert PanelView Standard terminals to the PanelView Plus 7 terminals.

Summary of Changes

This publication contains new and updated information as indicated in the following table.

Topic	Pages
Corrected the cutout dimensions of the PanelView Standard terminals.	15...39

Notes:

We Can Get You from Here ...

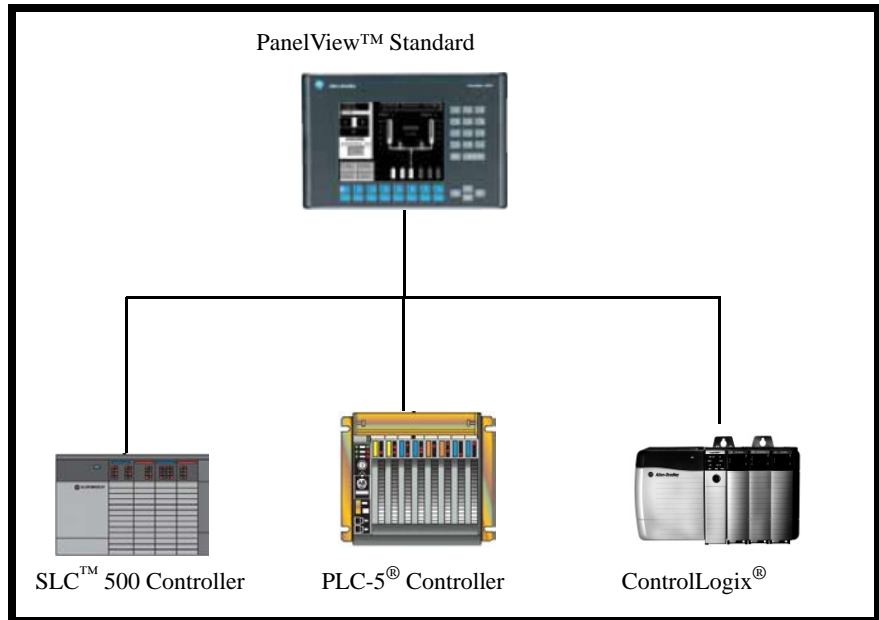

... to Here

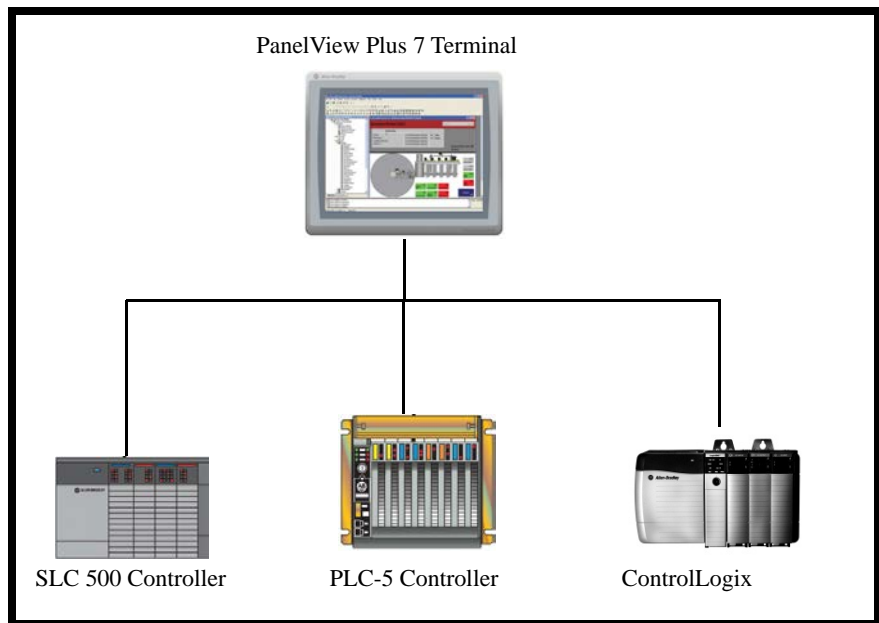

Follow this path to migrate your PanelView Standard terminal and application to the PanelView Plus 7 terminal platform.

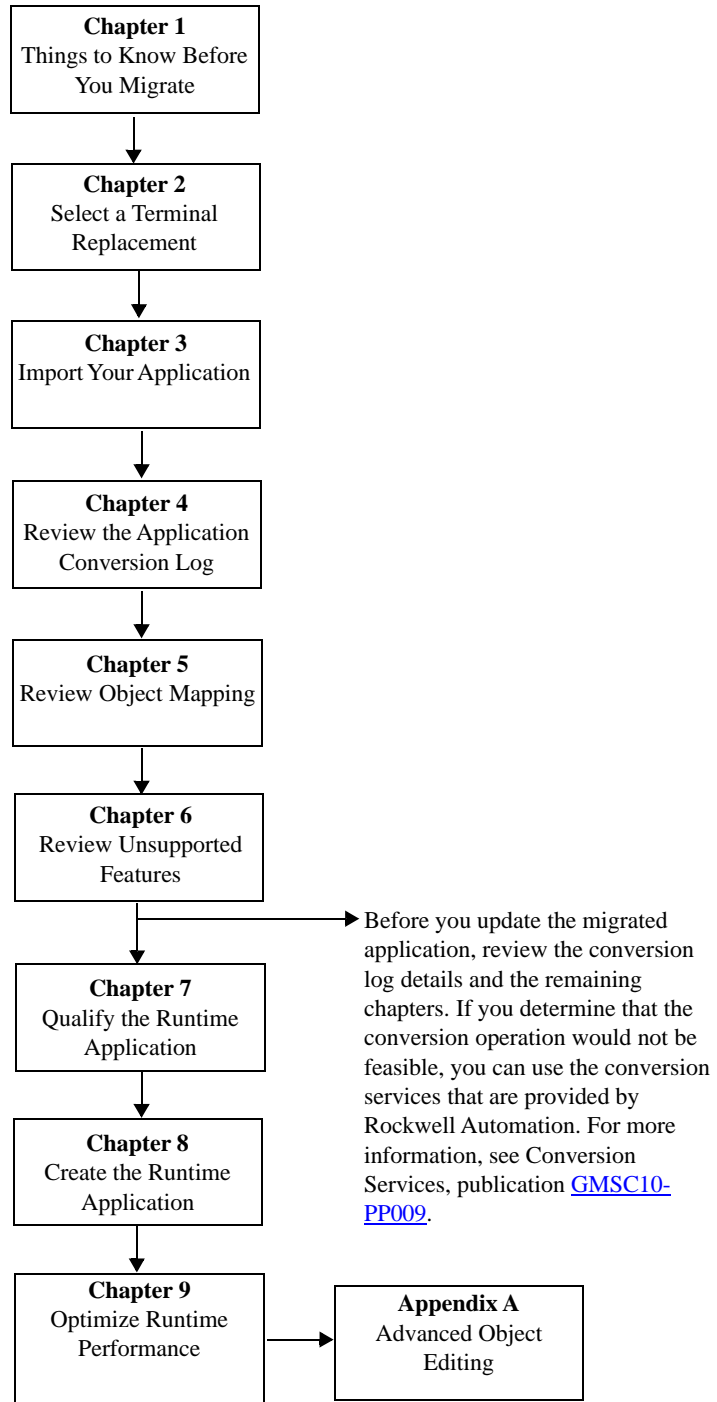

Introduction

This document provides guidelines and procedures for migrating a PanelView™ Standard terminal application to the PanelView Plus 7 terminal platform. The procedures and guidelines cover the following:

- Selecting and optionally installing a PanelView Plus 7 terminal replacement
- Importing your PanelView Standard application into the FactoryTalk® View Machine Edition software
- Updating the imported application and ladder logic, as necessary, for compatibility with FactoryTalk View Machine Edition software
- Reviewing unsupported features
- Verifying the correct operation of the imported application on the PanelView Plus 7 terminal
- Measuring and improving performance of the migrated application

The procedures and guidelines are designed to make the migration process as easy as possible.

The beginning of most chapters contains the following information. Read these sections carefully before beginning work in each chapter.

- **Before You Begin** - This section lists the steps that must be completed and decisions that must be made before starting the chapter. The chapters in this quick start must be completed or reviewed in the order in which they appear.
- **What You Need** - This section lists the items that are required to complete the steps in the current chapter. These items include, but are not limited to, hardware and software.
- **Follow These Steps** - This section illustrates the path or steps in the current chapter.

Also note that the electronic version of this publication contains links to other publications for easier navigation and reference.

Audience

This quick start was created to assist a user familiar with Rockwell Automation® HMI products on how to convert existing PanelView Standard applications to FactoryTalk View Machine Edition applications that run on PanelView Plus 7 terminals.

Required Software

The table lists the software that is required to convert a PanelView Standard application to a PanelView Plus 7 application.

Software	Terminal Type	Software Version
FactoryTalk View Studio, which includes: FactoryTalk View Machine Edition RSLinX® Enterprise	PanelView Plus 7 Standard	4.0 or later
	PanelView Plus 7 Performance	5.1 or earlier
	PanelView Plus 7 Performance	6.0 or later
PanelBuilder®32	—	3.83 or earlier

Things to Know Before You Migrate

Introduction

This chapter covers important considerations and helpful things to know before migrating a PanelView™ Standard application to a PanelView Plus 7 platform.

The table covers important considerations when migrating an application.

Table 1 - Migration Considerations

Migration Consideration	Explanation	For More Information
Application reuse?	Do you need to reuse your PanelView Standard application and PLC ladder logic? If so, you can convert your application for use with a PanelView Plus terminal using FactoryTalk® View Machine Edition (ME) software. The application and PLC ladder logic may require updates because some objects or features may not directly migrate to FactoryTalk View ME software. If you want to create a FactoryTalk View ME application instead of reusing your current application, stop here.	Refer to Reviewing Object Mapping on page 58 Refer to Reviewing Unsupported Features on page 62
Require enhanced features?	Does your application require enhanced features? If so, you can take advantage of the advanced features that are offered by the PanelView Plus 7 terminals: <ul style="list-style-type: none"> • Functions: trending, data logging, alarming, information and local messages, expressions, security, language switching, recipes, global objects, multiversion support, faceplates, graphic libraries, parameter files, rich graphics, and animation. • Communication: Ethernet and third-party connectivity to additional protocols. Ethernet is the preferred communication. • Hardware: 8-wire analog resistive touch screen, x86 1 GHz processor, 512 MB RAM and 512 MB nonvolatile memory, USB and Secure Digital (SD) media support, modular display, communication, and logic components. • Remote connectivity: FTP server, web server, VNC client/server, ActiveX controls, PDF reader, and FactoryTalk ViewPoint remote access is available on all PanelView Plus 7 Standard and Performance terminals. • Extended features: PanelView Plus 7 Performance terminals include a web browser, remote desktop connection, Microsoft Office file viewers, and WordPad text editor. 	
Terminal replacement options?	The terminal replacement for the PanelView Standard platform is the PanelView Plus 7 platform.	Refer to Selecting a Terminal Replacement on page 14

External Fonts

Before importing a PanelBuilder®32 application that uses external fonts, make sure that the external font file is in this directory:

C:\Program Files\Allen-Bradley\PBEX\Fonts

If the conversion utility does not find the external font in this location, the conversion stops without reporting an error.

Retain Last States on Startup

PanelBuilder32 software lets you choose to retain the last states on startup for all objects. FactoryTalk View Machine Edition (ME) software does not have this feature.

Unsupported Characters in Tag Names and Addresses

PanelBuilder32 software supports semicolons (;) in tag addresses; FactoryTalk View ME software does not. Before importing your application into FactoryTalk View ME software, change the semicolons (;) to colons (:) in the PanelBuilder32 tag editor.

PanelBuilder32 software supports dashes (-) in tag names, FactoryTalk View ME software does not. Before importing your application to FactoryTalk View ME software, search the PanelBuilder32 tag editor for tag names with dashes and duplicate the tags. Rename the tags to eliminate the dash, or replace the dash with an underscore (_). Use the tag search function to find graphic objects using the original tag names. Edit the objects to update the tag names.

Bit Array Tags

You can monitor bit arrays for alarm conditions in FactoryTalk View applications but you can't assign bit arrays to graphic objects, or write to bit arrays. This condition means all bit array tags in your PanelBuilder32 application are converted to memory tags in the FactoryTalk View ME application.

String Tags

At runtime, FactoryTalk View ME applications support a maximum length of 82 characters. Because PanelBuilder32 protocols support longer strings, some alarm messages may be truncated after conversion.

Alarm Trigger Tags

Bit arrays with the Bit or LSBit trigger types are used to trigger alarm messages in a FactoryTalk View ME application. Assigning alarm triggers to elements in a bit array, instead of bit addresses, frees up tags in the database for other uses. When an element of an array changes from 0 to 1, it can generate an alarm message if a message has been created for that bit position. With the Bit trigger type, you can generate simultaneous alarm messages, one for each element. With the LSB trigger type, only the lowest bit position triggers an alarm:

- In a PanelBuilder32 application, the trigger value for the bit data type ranges from 0...31.
- In a FactoryTalk View ME application, the trigger value for the bit data type ranges from 1...32.

The number of bits in the array depends on the data type of the tag. Integer data types, for example, return 16 bits per element, while Bit data types return 8 bits per element.

To trigger a digital alarm that is based on an array of controller bits, you must use a direct reference and the syntax:

tagname,Larraylength (for example, [PLC5]N7:0,L5)

TIP Don't leave a space between the tag address and the length. For example, the address {[SLC]BlockWrite1, L8}, where BlockWrite is the equivalent of N7:0, does not work. {[SLC]BlockWrite1,L8} works.

Bit Position Triggers

Follow these steps in the FactoryTalk View ME application to trigger alarms by using bit positions.

1. In the Trigger tab of the Alarm Setup editor, create a Bit type alarm trigger.
2. In the Trigger dialog box, click Browse in the Tag column and browse to the first element of an array.

For example, in a Logix5000™ controller that is called CLGX1, select AAIm[0], which is an integer tag type.

3. Click OK to insert the tag address into your trigger tag.

This address {[CLGX1]AAIm[0]} is the starting element in your array tag. [CLGX1] is the direct reference or the RSLinx® Enterprise device shortcut name.

4. Double-click the address and append a comma and the letter L to the address, then type the number of elements you want to include in your array tag.

To add 64 elements to the example address, modify it to read {[CLGX1]AAIm[0],L64}. This syntax returns (64 x 16 =) 1024 bits. Do not leave a space between the tag address and the length.

5. In the Messages tab, assign trigger values and alarm messages to as many of the elements in the array tag as you like.

Each trigger value corresponds to a bit position, not a bit address.

In the Trigger Value column, enter a number for the element that triggers the message, then create the message in the Message column. When that element in the array changes value, it triggers the alarm and display the message.

Bit Position	Trigger Value	Message
1	1	Line 1: Conveyor has stopped
2	2	Line 1: Power failure
3	3	Line 2: Conveyor has stopped
4	4	Line 2: Power failure
...
1024	1024	Line 6: Oven door open

Least Significant Bit Triggers

Follow these steps to trigger alarms using Least Significant Bit positions.

1. In the Trigger tab of the Alarm Setup editor, create an LSBit type alarm trigger.
2. In the Trigger dialog box, click Browse in the Tag column and browse to the first element of an array.

For example, in a PLC-5[®] controller, select an integer tag N7:61. For this example, only the first three-bit positions are used, so there's no need to specify a length (L) for the array. To also monitor bits in N7:62, add L2 to the address: [PLC5]N7:61,L2.

3. Specify these trigger values and alarm messages for the alarm trigger.

Bit in Array	Bit Position	Trigger Value	Message
00	1	1	Motor has lost power
01	2	2	Motor has stopped
02	3	3	Overload switch has lost power

If the motor loses power at runtime, all three-bit values change from 0 to 1. Only the first alarm message is generated, because bit 00 is the least significant or the lowest bit. If the operator acknowledges the first alarm and power is not yet restored, the second alarm is generated, and so on.

Alarm Messages

Both PanelBuilder 32 and Machine Edition applications perform the same three steps when an alarm is triggered.

1. Send the alarm message to the Data Tag connection.
2. Set the Notification Tag connection to 1.
3. Reset the Notification Tag connection to 0 when the Handshake tag changes to a nonzero value.

The PanelBuilder32 application performs additional steps that are not required by the ME application.

4. Send Null (00) to the Data Tag, overwriting the alarm message.
5. Set the Notification Tag to 1.
6. Reset the Notification Tag to 0 when the Handshake tag changes to a new nonzero value.

The Data tag is now ready to accept a new alarm message.

Tags Assigned to Message Connections

Some PanelBuilder32 tags are assigned to Message connections in the converted Machine Edition application.

This Tag in PanelBuilder32	Is Assigned to This Connection in ME
Remote Device Data tag	Message connection
Remote Device Notification tag	Message Notification connection
Remote Device Handshake tag	Message Handshake connection

Notes:

Select a Terminal Replacement

Introduction

In this chapter, you select and optionally install a PanelView™ Plus 7 terminal replacement for your PanelView Standard terminal.

Before You Begin

Review the migration considerations table (chapter 1).

Follow These Steps

Follow these steps to select a PanelView Plus 7 terminal as a replacement for your PanelView Standard terminal.

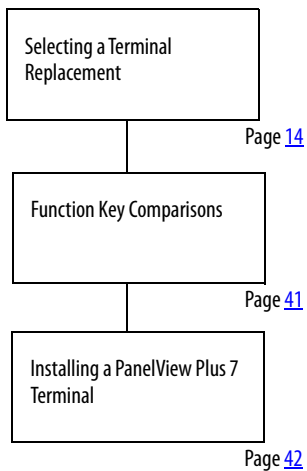

Selecting a Terminal Replacement

Replacement options for the PanelView Standard terminals include the following platforms:

- PanelView Plus 7 Performance terminals
- PanelView Plus 7 Standard terminals

Some of the PanelView Plus 7 terminals fit directly into the existing panel cutouts of the PanelView Standard terminals; others require an adapter kit.

None of the PanelView Plus 7 terminals fit into the panel cutouts of the PanelView Standard 300 or 300 Micro terminals.

- TIP**• References to PanelView Plus 700, 1000, 1250, or 1500 terminals apply to both the PanelView Plus 6 (700...1500) and PanelView Plus 700 to 1500 platforms.
- PanelView Plus Compact terminals use the same cutouts and adapter kits as the corresponding PanelView Plus 400, 600, and 1000 models.

Catalog Number Conversion Tables

Tables in this section provide a direct catalog number conversion for your PanelView Standard terminal to a compatible PanelView Plus 7 terminal.

PanelView Standard 300 and 300 Micro Terminals Conversions

See the tables in this section for primary and secondary conversions for PanelView Standard 300 and 300 Micro terminals.

PanelView Standard 300 and 300 Micro Terminals Primary Replacement Options

PanelView Standard Terminals						PanelView Plus 7 Terminals – Primary Replacement Options						
Model	Cat. No.	Panel Cutout Dimensions		Display Resolution	Comm.	Cat. No.	Panel Cutout Dimensions		Display Resolution	Comm.	Adapter Kit Cat. No.	Notes
		Height mm (in.)	Width mm (in.)				Height mm (in.)	Width mm (in.)				
300	2711-K3A5L1K	178 (6.99)	109 (4.29)	128 x 64	RS-232 (DF1)	2711P-T4W21D8S	92 (3.62)	117 (4.61)	480 x 272	One Ethernet port	N/A	PanelView Plus 7 Standard 4-in. terminal benefits: Higher resolution Application limits: • Max. screen count: 100 • Max. alarm messages: 500 • Max. number of controllers: 1 Communication = Ethernet (dual Ethernet ports are available). Operator input = only touch. Power input = only DC. Conformal coat = No.
	2711-K3A10L1				DH-485							
	2711-K3A17L1				RS-232 (D-485)							
	2711-K3A2L1				RS-232 (D-485)							
	2711-K3A5L1				DeviceNet and RS-232							
300 Micro	2711-M3A18L1	102 (4.00)	92 (3.62)	128 x 64	RS-232 (DF1)	2711P-T4W21D8S	92 (3.62)	117 (4.61)	480 x 272	One Ethernet port	N/A	PanelView Plus 7 Standard 4-in. terminal benefits: Higher resolution Application limits: • Max. screen count: 100 • Max. alarm messages: 500 • Max. number of controllers: 1 Communication = Ethernet (dual Ethernet ports are available). Operator input = only touch. Power input = only DC. Conformal coat = No.
	2711-M3A19L1				RS-232 (DF1)							

PanelView Standard 300 and 300 Micro Terminals Secondary Replacement Options

PanelView Standard Terminals						PanelView Plus 7 Terminals – Secondary Replacement Options						
Model	Cat. No.	Panel Cutout Dimensions		Display Resolution	Comm.	Cat. No.	Panel Cutout Dimensions		Display Resolution	Comm.	Adapter Kit Cat. No.	Notes
		Height mm (in.)	Width mm (in.)				Height mm (in.)	Width mm (in.)				
300	2711-K3A5L1K	178 (6.99)	109 (4.29)	128 x 64	RS-232 (DF1)	2711P-B7C22D9P	142 (5.59)	237 (9.33)	640 x 480	Dual Ethernet ports	N/A	PanelView Plus 7 Performance 6.5 in. terminal benefits: • Higher resolution • DLR Communication = Ethernet. Operator input = keypad and touch. Power input = only DC. Conformal coat = No.
	2711-K3A10L1				DH-485							
	2711-K3A17L1				RS-232 (D-485)							
	2711-K3A2L1				RS-232 (D-485)							
	2711-K3A5L1				DeviceNet and RS-232							
300 Micro	2711-M3A18L1	102 (4.00)	92 (3.62)	128 x 64	RS-232 (DF1)	2711P-B7C22D9P	142 (5.59)	237 (9.33)	640 x 480	Dual Ethernet ports	N/A	PanelView Plus 7 Performance 6.5 in. terminal benefits: • Higher resolution • DLR Communication = Ethernet. Operator input = keypad and touch. Power input = only DC. Conformal coat = No.
	2711-M3A19L1				RS-232 (DF1)							

PanelView Standard 550 Terminals Conversions

See the tables in this section for primary and secondary conversions for PanelView Standard 550 terminals.

PanelView Standard 550 Terminals Primary Replacement Options

PanelView Standard Terminals						PanelView Plus 7 Terminals – Primary Replacement Options						
Model	Cat. No.	Panel Cutout Dimensions		Display Resolution	Comm.	Cat. No.	Panel Cutout Dimensions		Display Resolution	Comm.	Adapter Kit Cat. No.	Notes
		Height mm (in.)	Width mm (in.)				Height mm (in.)	Width mm (in.)				
550	2711-K5A1	144 (5.66)	243 (9.55)	256 x 128	Remote I/O	2711P-T6C21D8S	123 (4.84)	156 (6.14)	640 x 480	One Ethernet port	N/A	PanelView Plus 7 Standard 6 in. terminal benefits: Higher resolution Application limits: • Max. screen count: 100 • Max. alarm messages: 500 • Max. number of controllers: 1 Communication = Ethernet (dual Ethernet ports are available). Operator input = only touch. Power input = only DC. Conformal coat = No.
	2711-K5A1L1											
	2711-K5A10											
	2711-K5A10L1											
	2711-K5A14				DeviceNet							
	2711-K5A14L1											
	2711-K5A12				RS-232							
	2711-K5A12L1											
	2711-K5A16				RS-232 (DF1)							
	2711-K5A16L1											
	2711-K5A15				ControlNet							
	2711-K5A15L1											
	2711-K5A2				DH-485							
	2711-K5A2L1											
	2711-K5A3											
	2711-K5A3L1											
	2711-K5A5				RS-232 (DH-485)							
	2711-K5A5L1											
	2711-K5A9											
	2711-K5A9L1											
	2711-K5A8				DH+™							
	2711-K5A8L1											
	2711-K5A20				EtherNet/IP							
	2711-K5A20L1											
	2711-B5A1				Remote I/O							
	2711-B5A1L1											
	2711-B5A10				DeviceNet							
	2711-B5A10L1											
	2711-B5A14											
	2711-B5A14L1											
2711-B5A12	RS-232											
2711-B5A12L1												
2711-B5A16	RS-232 (DF1)											
2711-B5A16L1												

PanelView Standard 550 Terminals Primary Replacement Options (Continued)

PanelView Standard Terminals						PanelView Plus 7 Terminals – Primary Replacement Options						
Model	Cat. No.	Panel Cutout Dimensions		Display Resolution	Comm.	Cat. No.	Panel Cutout Dimensions		Display Resolution	Comm.	Adapter Kit Cat. No.	Notes
		Height mm (in.)	Width mm (in.)				Height mm (in.)	Width mm (in.)				
550	2711-B5A15	144 (5.66)	243 (9.55)	256 x 128	ControlNet	2711P-T6C21D85	123 (4.84)	156 (6.14)	640 x 480	One Ethernet port	N/A	PanelView Plus 7 Standard 6 in. terminal benefits: Higher resolution Application limits: • Max. screen count: 100 • Max. alarm messages: 500 • Max. number of controllers: 1 Communication = Ethernet (dual Ethernet ports are available). Operator input = only touch. Power input = only DC. Conformal coat = No.
	2711-B5A15L1											
	2711-B5A2				DH-485							
	2711-B5A2L1											
	2711-B5A3											
	2711-B5A3L1											
	2711-B5A5				RS-232 (DH-485)							
	2711-B5A5L1											
	2711-B5A9											
	2711-B5A9L1											
	2711-B5A8				DH+							
	2711-B5A8L1											
	2711-B5A20				EtherNet/IP							
	2711-B5A20L1											
	2711-T5A1L1	125 (4.91)	158 (6.20)	256 x 128	Remote I/O							
	2711-T5A10L1				DeviceNet							
	2711-T5A14L1				RS-232							
	2711-T5A12L1											
	2711-T5A16L1				RS-232 (DF1)							
	2711-T5A15L1				ControlNet							
	2711-T5A2L1				DH-485							
	2711-T5A3L1											
	2711-T5A5L1				RS-232 (DH-485)							
	2711-T5A9L1											
	2711-T5A8L1				DH+							
	2711-T5A20L1				EtherNet/IP							

PanelView Standard 550 Terminals Secondary Replacement Options

PanelView Standard Terminals						PanelView Plus 7 Terminals – Secondary Replacement Options						
Model	Cat. No.	Panel Cutout Dimensions		Display Resolution	Comm.	Cat. No.	Panel Cutout Dimensions		Display Resolution	Comm.	Adapter Kit Cat. No.	Notes
		Height mm (in.)	Width mm (in.)				Height mm (in.)	Width mm (in.)				
550	2711-K5A1	144 (5.66)	243 (9.55)	256 x 128	Remote I/O	2711P-B7C22A9P ⁽¹⁾	142 (5.59)	237 (9.33)	640 x 480	Dual Ethernet ports	N/A	PanelView Plus 7 Performance 6.5 in. terminal benefits: • Higher resolution • DLR Communication = Ethernet. Operator input = keypad and touch. Power input = AC or DC. ⁽¹⁾ Conformal coat = No.
	2711P-B7C22D9P											
	DeviceNet				2711P-B7C22A9P ⁽¹⁾							
					2711P-B7C22D9P							
					2711P-B7C22A9P ⁽¹⁾							
					2711P-B7C22D9P							
	RS-232				2711P-B7C22A9P ⁽¹⁾							
					2711P-B7C22D9P							
	RS-232 (DF1)				2711P-B7C22A9P ⁽¹⁾							
					2711P-B7C22D9P							
	ControlNet				2711P-B7C22A9P ⁽¹⁾							
					2711P-B7C22D9P							
	DH-485				2711P-B7C22A9P ⁽¹⁾							
					2711P-B7C22D9P							
					2711P-B7C22A9P ⁽¹⁾							
					2711P-B7C22D9P							
	RS-232 (DH-485)				2711P-B7C22A9P ⁽¹⁾							
					2711P-B7C22D9P							
					2711P-B7C22A9P ⁽¹⁾							
					2711P-B7C22D9P							
	DH+				2711P-B7C22A9P ⁽¹⁾							
					2711P-B7C22D9P							
	EtherNet/IP				2711P-B7C22A9P ⁽¹⁾							
					2711P-B7C22D9P							
	Remote I/O				2711P-B7C22A9P ⁽¹⁾							
					2711P-B7C22D9P							
	DeviceNet				2711P-B7C22A9P ⁽¹⁾							
					2711P-B7C22D9P							
					2711P-B7C22A9P ⁽¹⁾							
					2711P-B7C22D9P							
	RS-232				2711P-B7C22A9P ⁽¹⁾							
					2711P-B7C22D9P							
RS-232 (DF1)	2711P-B7C22A9P ⁽¹⁾											
	2711P-B7C22D9P											

PanelView Standard 550 Terminals Secondary Replacement Options (Continued)

PanelView Standard Terminals					PanelView Plus 7 Terminals – Secondary Replacement Options							
Model	Cat. No.	Panel Cutout Dimensions		Display Resolution	Comm.	Cat. No.	Panel Cutout Dimensions		Display Resolution	Comm.	Adapter Kit Cat. No.	Notes
		Height mm (in.)	Width mm (in.)				Height mm (in.)	Width mm (in.)				
550	2711-B5A15	144 (5.66)	243 (9.55)	256 x 128	ControlNet	2711P-B7C22A9P ⁽¹⁾	142 (5.59)	237 (9.33)	640 x 480	Dual Ethernet ports	N/A	PanelView Plus 7 Performance 6.5 in. terminal benefits: • Higher resolution • DLR Communication = Ethernet. Operator input = keypad and touch. Power input = AC or DC. ⁽¹⁾ Conformal coat = No.
	2711-B5A15L1					2711P-B7C22D9P						
	2711-B5A2				DH-485	2711P-B7C22A9P ⁽¹⁾						
	2711-B5A2L1					2711P-B7C22D9P						
	2711-B5A3					2711P-B7C22A9P ⁽¹⁾						
	2711-B5A3L1				RS-232 (DH-485)	2711P-B7C22D9P						
	2711-B5A5					2711P-B7C22A9P ⁽¹⁾						
	2711-B5A5L1					2711P-B7C22D9P						
	2711-B5A9					2711P-B7C22A9P ⁽¹⁾						
	2711-B5A9L1				DH+	2711P-B7C22D9P						
	2711-B5A8					2711P-B7C22A9P ⁽¹⁾						
	2711-B5A8L1				EtherNet/IP	2711P-B7C22D9P						
	2711-B5A20					2711P-B7C22A9P ⁽¹⁾						
	2711-B5A20L1					2711P-B7C22D9P						
	2711-T5A1L1	125 (4.91)	158 (6.20)	256 x 128		Remote I/O	2711P-T7C22D9P	142 (5.59)	184 (7.24)	640 x 480	Dual Ethernet ports	N/A
	2711-T5A10L1				DeviceNet							
	2711-T5A14L1				RS-232							
	2711-T5A12L1				RS-232 (DF1)							
	2711-T5A16L1				ControlNet							
	2711-T5A15L1				DH-485							
2711-T5A2L1	RS-232 (DH-485)											
2711-T5A3L1	DH+											
2711-T5A5L1	EtherNet/IP											
2711-T5A9L1												
2711-T5A8L1												
2711-T5A20L1												

(1) AC power is only available on Series A terminals. DC power is only available on Series B terminals.

(2) Conformal coating is available for all DC-power, touch terminals. To order a terminal that is conformal-coated, add K to the end of a DC-power, touch catalog number; for example, 2711P-T7C22D9PK.

PanelView Standard 600 Terminals Conversions

See the tables in this section for primary and secondary conversions for PanelView Standard 600 terminals.

PanelView Standard 600 Terminals Primary Replacement Options

PanelView Standard Terminals					PanelView Plus 7 Terminals – Primary Replacement Options							
Model	Cat. No.	Panel Cutout Dimensions		Display Resolution	Comm.	Cat. No.	Panel Cutout Dimensions		Display Resolution	Comm.	Adapter Kit Cat. No.	Notes
		Height mm (in.)	Width mm (in.)				Height mm (in.)	Width mm (in.)				
600	2711-K6C1	167 (6.57)	264 (10.39)	320 x 234	Remote I/O	2711P-B7C22A9P ⁽¹⁾	142 (5.59)	237 (9.33)	640 x 480	Dual Ethernet ports	2711P-RAAK7	PanelView Plus 7 Performance 6.5 in. terminals benefits: • Higher resolution • DLR Communication = Ethernet. Operator input = keypad and touch. Power input = AC or DC. ⁽¹⁾ Conformal coat = No. Adapter kit is necessary for drop-in replacement.
	2711P-B7C22D9P											
	DeviceNet				2711P-B7C22A9P ⁽¹⁾							
					2711P-B7C22D9P							
					2711P-B7C22A9P ⁽¹⁾							
					2711P-B7C22D9P							
					RS-232	2711P-B7C22A9P ⁽¹⁾						
						2711P-B7C22D9P						
	RS-232 (DF1)				2711P-B7C22A9P ⁽¹⁾							
					2711P-B7C22D9P							
	ControlNet				2711P-B7C22A9P ⁽¹⁾							
					2711P-B7C22D9P							
	DH-485				2711P-B7C22A9P ⁽¹⁾							
					2711P-B7C22D9P							
					2711P-B7C22A9P ⁽¹⁾							
					2711P-B7C22D9P							
	RS-232 (DH-485)				2711P-B7C22A9P ⁽¹⁾							
					2711P-B7C22D9P							
					2711P-B7C22A9P ⁽¹⁾							
					2711P-B7C22D9P							
	DH+				2711P-B7C22A9P ⁽¹⁾							
					2711P-B7C22D9P							
	EtherNet/IP				2711P-B7C22A9P ⁽¹⁾							
					2711P-B7C22D9P							
	Remote I/O				2711P-B7C22A9P ⁽¹⁾							
					2711P-B7C22D9P							
	DeviceNet				2711P-B7C22A9P ⁽¹⁾							
					2711P-B7C22D9P							
					2711P-B7C22A9P ⁽¹⁾							
					2711P-B7C22D9P							
	RS-232				2711P-B7C22A9P ⁽¹⁾							
					2711P-B7C22D9P							
RS-232 (DF1)	2711P-B7C22A9P ⁽¹⁾											
	2711P-B7C22D9P											

PanelView Standard 600 Terminals Primary Replacement Options (Continued)

PanelView Standard Terminals						PanelView Plus 7 Terminals – Primary Replacement Options															
Model	Cat. No.	Panel Cutout Dimensions		Display Resolution	Comm.	Cat. No.	Panel Cutout Dimensions		Display Resolution	Comm.	Adapter Kit Cat. No.	Notes									
		Height mm (in.)	Width mm (in.)				Height mm (in.)	Width mm (in.)													
600	2711-B6C15	167 (6.57)	264 (10.39)	320 x 234	ControlNet	2711P-B7C22A9P ⁽¹⁾	142 (5.59)	237 (9.33)	640 x 480	Dual Ethernet ports	2711P-RAAK7	PanelView Plus 7 Performance 6.5 in. terminal benefits: • Higher resolution • DLR Communication = Ethernet. Operator input = keypad and touch. Power input = AC or DC. ⁽¹⁾ Conformal coat = No. Adapter kit is necessary for drop-in replacement.									
	2711P-B7C22D9P																				
	2711-B6C2				DH-485	2711P-B7C22A9P ⁽¹⁾															
	2711-B6C2L1					2711P-B7C22D9P															
	2711-B6C3					2711P-B7C22A9P ⁽¹⁾															
	2711-B6C3L1				RS-232 (DH-485)	2711P-B7C22D9P															
	2711-B6C5					2711P-B7C22A9P ⁽¹⁾															
	2711-B6C5L1					2711P-B7C22D9P															
	2711-B6C9					2711P-B7C22A9P ⁽¹⁾															
	2711-B6C9L1				DH+	2711P-B7C22D9P															
	2711-B6C8					2711P-B7C22A9P ⁽¹⁾															
	2711-B6C8L1				EtherNet/IP	2711P-B7C22D9P															
	2711-B6C20					2711P-B7C22A9P ⁽¹⁾															
	2711-B6C20L1					2711P-B7C22D9P															
	2711-B6C20L1					2711P-B7C22D9P															
	2711-T6C1L1				125 (4.91)	158 (6.20)							320 x 234	Remote I/O	2711P-T6C21D8S	123 (4.84)	156 (6.14)	640 x 480	One Ethernet port	N/A	PanelView Plus 7 Standard 6 in. terminal benefits: Higher resolution Application limits: • Max. screen count: 100 • Max. alarm messages: 500 • Max. number of controllers: 1 Communication = Ethernet (dual Ethernet ports are available). Operator input = only touch. Power input = only DC. Conformal coat = No.
	2711-T6C10L1													DeviceNet							
	2711-T6C14L1													RS-232							
2711-T6C12L1	RS-232 (DF1)																				
2711-T6C16L1	ControlNet																				
2711-T6C15L1	DH-485																				
2711-T6C2L1	RS-232 (DH-485)																				
2711-T6C3L1	DH+																				
2711-T6C5L1	EtherNet/IP																				
2711-T6C9L1																					
2711-T6C8L1																					
2711-T6C20L1																					

(1) AC power is only available on Series A terminals. DC power is only available on Series B terminals.

PanelView Standard 600 Terminals Secondary Replacement Options

PanelView Standard Terminals						PanelView Plus 7 Terminals – Secondary Replacement Options						
Model	Cat. No.	Panel Cutout Dimensions		Display Resolution	Comm.	Cat. No.	Panel Cutout Dimensions		Display Resolution	Comm.	Adapter Kit Cat. No.	Notes
		Height mm (in.)	Width mm (in.)				Height mm (in.)	Width mm (in.)				
600	2711-K6C1	167 (6.57)	264 (10.39)	320 x 234	Remote I/O	2711P-T7C21D8S	142 (5.59)	184 (7.24)	640 x 480	One Ethernet port	N/A	PanelView Plus 7 Standard 6.5 in. terminal benefits: Higher resolution Application limits: • Max. screen count: 100 • Max. alarm messages: 500 • Max. number of controllers: 1 Communication = Ethernet (dual Ethernet ports are available). Operator input = only touch. Power input = only DC. Conformal coat = No.
	2711-K6C1L1											
	2711-K6C10											
	2711-K6C10L1											
	2711-K6C14				DeviceNet							
	2711-K6C14L1											
	2711-K6C12				RS-232							
	2711-K6C12L1											
	2711-K6C16				RS-232 (DF1)							
	2711-K6C16L1											
	2711-K6C15				ControlNet							
	2711-K6C15L1											
	2711-K6C2											
	2711-K6C2L1				DH-485							
	2711-K6C3											
	2711-K6C3L1											
	2711-K6C5											
	2711-K6C5L1				RS-232 (DH-485)							
	2711-K6C9											
	2711-K6C9L1											
	2711-K6C8				DH+							
	2711-K6C8L1											
	2711-K6C20				EtherNet/IP							
	2711-K6C20L1											
	2711-B6C1				Remote I/O							
	2711-B6C1L1											
	2711-B6C10											
	2711-B6C10L1				DeviceNet							
	2711-B6C14											
	2711-B6C14L1											
2711-B6C12	RS-232											
2711-B6C12L1												
2711-B6C16												
2711-B6C16L1	RS-232 (DF1)											

PanelView Standard 600 Terminals Secondary Replacement Options (Continued)

PanelView Standard Terminals					PanelView Plus 7 Terminals – Secondary Replacement Options							
Model	Cat. No.	Panel Cutout Dimensions		Display Resolution	Comm.	Cat. No.	Panel Cutout Dimensions		Display Resolution	Comm.	Adapter Kit Cat. No.	Notes
		Height mm (in.)	Width mm (in.)				Height mm (in.)	Width mm (in.)				
600	2711-B6C15	167 (6.57)	264 (10.39)	320 x 234	ControlNet	2711P-T7C21D8S	142 (5.59)	184 (7.24)	640 x 480	One Ethernet port	N/A	PanelView Plus 7 Standard 6.5 in. terminal benefits: Higher resolution Application limits: • Max. screen count: 100 • Max. alarm messages: 500 • Max. number of controllers: 1 Communication = Ethernet (dual Ethernet ports are available). Operator input = only touch. Power input = only DC. Conformal coat = No.
	2711-B6C15L1											
	2711-B6C2											
	2711-B6C2L1											
	2711-B6C3											
	2711-B6C3L1											
	2711-B6C5											
	2711-B6C5L1											
	2711-B6C9											
	2711-B6C9L1											
	2711-B6C8											
	2711-B6C8L1											
	2711-B6C20											
	2711-B6C20L1											
2711-T6C1L1	125 (4.91)	158 (6.20)	320 x 234	Remote I/O	2711P-T7C22D9P	142 (5.59)	184 (7.24)	640 x 480	Dual Ethernet ports	N/A	PanelView Plus 7 Performance 6.5 in. terminal benefits: • Higher resolution • DLR Communication = Ethernet. Operator input = keypad and touch. Power input = AC or DC. ⁽¹⁾ Conformal coat = Yes. ⁽²⁾ Adapter kit is necessary for drop-in replacement.	
2711-T6C10L1				DeviceNet								
2711-T6C14L1												
2711-T6C12L1				RS-232								
2711-T6C16L1				RS-232 (DF1)								
2711-T6C15L1				ControlNet								
2711-T6C2L1				DH-485								
2711-T6C3L1												
2711-T6C5L1				RS-232 (DH-485)								
2711-T6C9L1												
2711-T6C8L1				DH+								
2711-T6C20L1				EtherNet/IP								

(1) AC power is only available on Series A terminals. DC power is only available on Series B terminals.

(2) Conformal coating is available for all DC-power, touch terminals. To order a terminal that is conformal-coated, add K to the end of a DC-power, touch catalog number; for example, 2711P-T7C22D9PK.

PanelView Standard 900 Terminals Conversions

See the tables in this section for primary and secondary conversions for PanelView Standard 900 terminals.

PanelView Standard 900 Terminals Primary Replacement Options

PanelView Standard Terminals					PanelView Plus 7 Terminals – Primary Replacement Options									
Model	Cat. No.	Panel Cutout Dimensions		Display Resolution	Comm.	Cat. No.	Panel Cutout Dimensions		Display Resolution	Comm.	Adapter Kit Cat. No.	Notes		
		Height mm (in.)	Width mm (in.)				Height mm (in.)	Width mm (in.)						
900	2711-K9A1	224 (8.80)	375 (14.75)	640 x 400	Remote I/O	2711P-B10C22A9P	224 (8.82)	335 (13.19)	800 x 600	Dual Ethernet ports	2711P-RAAK10	PanelView Plus 7 Performance 10.4 in. terminal benefits: • Higher resolution • DLR Communication = Ethernet. Operator input = keypad and touch. Power input = AC or DC. ⁽¹⁾ Conformal coat = No. Adapter kit is necessary for drop-in replacement.		
	2711P-B10C22D9P													
	2711-K9A10				DeviceNet	2711P-B10C22A9P								
	2711P-B10C22D9P													
	2711-K9A10L1				RS-232	2711P-B10C22D9P								
	2711-K9A14L1					2711P-B10C22D9P								
	2711-K9A12					2711P-B10C22A9P								
	2711-K9A12L1					2711P-B10C22D9P								
	2711-K9A5				ControlNet	2711P-B10C22A9P								
	2711-K9A5L1					2711P-B10C22D9P								
	2711-K9A9					2711P-B10C22A9P								
	2711-K9A9L1					2711P-B10C22D9P								
	2711-K9A15				DH-485	2711P-B10C22A9P								
	2711-K9A15L1					2711P-B10C22D9P								
	2711-K9A2					2711P-B10C22A9P								
	2711-K9A2L1					2711P-B10C22D9P								
	2711-K9A3				DH+	2711P-B10C22A9P								
	2711-K9A3L1					2711P-B10C22D9P								
	2711-K9A8				640 x 480								Remote I/O	2711P-B10C22A9P
	2711-K9A8L1													2711P-B10C22D9P
	2711-K9C1			DeviceNet									2711P-B10C22A9P	
	2711-K9C1L1												2711P-B10C22D9P	
	2711-K9C10												2711P-B10C22A9P	
	2711-K9C10L1												2711P-B10C22D9P	
	2711-K9C14			RS-232									2711P-B10C22A9P	
	2711-K9C14L1												2711P-B10C22D9P	
	2711-K9C12												2711P-B10C22A9P	
	2711-K9C12L1												2711P-B10C22D9P	
	2711-K9C9			RS-232 (DF1)									2711P-B10C22A9P	
	2711-K9C9L1												2711P-B10C22D9P	
	2711-K9C16												2711P-B10C22A9P	
	2711-K9C16L1												2711P-B10C22D9P	
2711-K9C15	ControlNet	2711P-B10C22A9P												
2711-K9C15L1		2711P-B10C22D9P												
2711-K9C3	DH-485		2711P-B10C22A9P											

PanelView Standard 900 Terminals Primary Replacement Options (Continued)

PanelView Standard Terminals						PanelView Plus 7 Terminals – Primary Replacement Options						
Model	Cat. No.	Panel Cutout Dimensions		Display Resolution	Comm.	Cat. No.	Panel Cutout Dimensions		Display Resolution	Comm.	Adapter Kit Cat. No.	Notes
		Height mm (in.)	Width mm (in.)				Height mm (in.)	Width mm (in.)				
900	2711-K9C3L1	224 (8.80)	375 (14.75)	640 x 480	DH-485	2711P-B10C22D9P	224 (8.82)	335 (13.19)	800 x 600	Dual Ethernet ports	2711P-RAAK10	PanelView Plus 7 Performance 10.4 in. terminal benefits: • Higher resolution • DLR Communication = Ethernet. Operator input = keypad and touch. Power input = AC or DC. ⁽¹⁾ Conformal coat = No. Adapter kit is necessary for drop-in replacement.
	2711-K9C8				DH+	2711P-B10C22A9P						
	2711-K9C8L1					2711P-B10C22D9P						
	2711-K9C20					2711P-B10C22A9P						
	2711-K9C20L1				Ethernet	2711P-B10C22D9P						
	2711-T9A1	224 (8.80)	305 (12.00)	640 x 400	Remote I/O	2711P-T10C22A9P	224 (8.82)	269 (10.59)	800 x 600	Dual Ethernet ports	2711P-RAAT10	PanelView Plus 7 Performance 10.4 in. terminal benefits: • Higher resolution • DLR Communication = Ethernet. Operator input = only touch. Power input = AC or DC. ⁽¹⁾ Conformal coat = Yes ⁽²⁾ Adapter kit is necessary for drop-in replacement.
	2711-T9A1L1					2711P-T10C22D9P						
	2711-T9A10				DeviceNet	2711P-T10C22A9P						
	2711-T9A10L1					2711P-T10C22D9P						
	2711-T9A14L1				RS-232	2711P-T10C22D9P						
	2711-T9A12					2711P-T10C22A9P						
	2711-T9A12L1					2711P-T10C22D9P						
	2711-T9A5					2711P-T10C22A9P						
	2711-T9A5L1					2711P-T10C22D9P						
	2711-T9A9					2711P-T10C22A9P						
	2711-T9A9L1					2711P-T10C22D9P						
	2711-T9A15				ControlNet	2711P-T10C22A9P						
	2711-T9A15L1					2711P-T10C22D9P						
	2711-T9A2				DH-485	2711P-T10C22A9P						
	2711-T9A2L1					2711P-T10C22D9P						
	2711-T9A3					2711P-T10C22A9P						
	2711-T9A3L1					2711P-T10C22D9P						
	2711-T9A8				DH+	2711P-T10C22A9P						
	2711-T9A8L1					2711P-T10C22D9P						
	2711-T9C1				224 (8.80)	305 (12.00)						
	2711-T9C1L1		2711P-T10C22D9P									
	2711-T9C10	DeviceNet	2711P-T10C22A9P									
	2711-T9C10L1		2711P-T10C22D9P									
	2711-T9C14		2711P-T10C22A9P									
	2711-T9C14L1		2711P-T10C22D9P									
	2711-T9C12	RS-232	2711P-T10C22A9P									
	2711-T9C12L1		2711P-T10C22D9P									
	2711-T9C16	RS-232 (DF1)	2711P-T10C22A9P									
2711-T9C16L1	2711P-T10C22D9P											
2711-T9C15	ControlNet	2711P-T10C22A9P										

PanelView Standard 900 Terminals Primary Replacement Options (Continued)

PanelView Standard Terminals						PanelView Plus 7 Terminals – Primary Replacement Options						
Model	Cat. No.	Panel Cutout Dimensions		Display Resolution	Comm.	Cat. No.	Panel Cutout Dimensions		Display Resolution	Comm.	Adapter Kit Cat. No.	Notes
		Height mm (in.)	Width mm (in.)				Height mm (in.)	Width mm (in.)				
900	2711-T9C15L1	224 (8.80)	305 (12.00)	640 x 480	ControlNet	2711P-T10C22D9P	224 (8.82)	269 (10.59)	800 x 600	Dual Ethernet ports	2711P-RAAT10	PanelView Plus 7 Performance 10.4 in. terminal benefits: • Higher resolution • DLR Communication = Ethernet. Operator input = only touch. Power input = AC or DC. ⁽¹⁾ Conformal coat = Yes ⁽²⁾ Adapter kit is necessary for drop-in replacement.
					DH-485	2711P-T10C22A9P						
						2711P-T10C22D9P						
					RS-232 (DH-485)	2711P-T10C22A9P						
						2711P-T10C22D9P						
					DH+	2711P-T10C22A9P						
						2711P-T10C22D9P						
					Ethernet	2711P-T10C22A9P						
						2711P-T10C22D9P						

(1) AC power is only available on Series A terminals. DC power is only available on Series B terminals.

(2) Conformal coating is available for all DC-power, touch terminals. To order a terminal that is conformal-coated, add K to the end of a DC-power, touch catalog number; for example, 2711P-T10C22D9PK.

PanelView Standard 900 Terminals Secondary Replacement Options

PanelView Standard Terminals						PanelView Plus 7 Terminals – Secondary Replacement Options						
Model	Cat. No.	Panel Cutout Dimensions		Display Resolution	Comm.	Cat. No.	Panel Cutout Dimensions		Display Resolution	Comm.	Adapter Kit Cat. No.	Notes
		Height mm (in.)	Width mm (in.)				Height mm (in.)	Width mm (in.)				
900	2711-K9A1	224 (8.80)	375 (14.75)	640 x 400	Remote I/O	2711P-T10C21D8S	224 (8.82)	269 (10.59)	800 x 600	One Ethernet port	N/A	PanelView Plus 7 Standard 10.4 in. terminal benefits: Higher resolution Application limits: • Max. screen count: 100 • Max. alarm messages: 500 • Max. number of controllers: 1 Communication = Ethernet (dual Ethernet ports are available). Operator input = only touch. Power input = only DC. Conformal coat = No.
	2711-K9A1L1											
	2711-K9A10											
	2711-K9A10L1				DeviceNet							
	2711-K9A14L1											
	2711-K9A12											
	2711-K9A12L1											
	2711-K9A5				RS-232							
	2711-K9A5L1											
	2711-K9A9											
	2711-K9A9L1											
	2711-K9A15				ControlNet							
	2711-K9A15L1											
	2711-K9A2											
	2711-K9A2L1				DH-485							
	2711-K9A3											
	2711-K9A3L1											
	2711-K9A8			DH+								
	2711-K9A8L1											
	2711-K9C1			Remote I/O								
	2711-K9C1L1											
	2711-K9C10											
	2711-K9C10L1			DeviceNet								
	2711-K9C14											
	2711-K9C14L1											
	2711-K9C12											
	2711-K9C12L1			640 x 480								
	2711-K9C9			RS-232								
	2711-K9C9L1											
	2711-K9C16			RS-232 (DF1)								
	2711-K9C16L1											
	2711-K9C15			ControlNet								
2711-K9C15L1												
2711-K9C3	DH-485											

PanelView Standard 900 Terminals Secondary Replacement Options (Continued)

PanelView Standard Terminals					PanelView Plus 7 Terminals – Secondary Replacement Options							
Model	Cat. No.	Panel Cutout Dimensions		Display Resolution	Comm.	Cat. No.	Panel Cutout Dimensions		Display Resolution	Comm.	Adapter Kit Cat. No.	Notes
		Height mm (in.)	Width mm (in.)				Height mm (in.)	Width mm (in.)				
900	2711-K9C3L1	224 (8.80)	375 (14.75)	640 x 480	DH-485	2711P-T10C21D85	224 (8.82)	269 (10.59)	800 x 600	One Ethernet port	N/A	PanelView Plus 7 Standard 10.4 in. terminal benefits: Higher resolution Application limits: • Max. screen count: 100 • Max. alarm messages: 500 • Max. number of controllers: 1 Communication = Ethernet (dual Ethernet ports are available). Operator input = only touch. Power input = only DC. Conformal coat = No.
	2711-K9C8				DH+							
	2711-K9C8L1				Ethernet							
	2711-K9C20											
	2711-K9C20L1											
	2711-T9A1	224 (8.80)	305 (12.00)	640 x 400	Remote I/O							
	2711-T9A1L1											
	2711-T9A10											
	2711-T9A10L1				DeviceNet							
	2711-T9A14L1											
	2711-T9A12											
	2711-T9A12L1											
	2711-T9A5											
	2711-T9A5L1				RS-232							
	2711-T9A9											
	2711-T9A9L1											
	2711-T9A15											
	2711-T9A15L1	ControlNet										
	2711-T9A2											
	2711-T9A2L1											
	2711-T9A3											
	2711-T9A3L1											
	2711-T9A8											
	2711-T9A8L1											
	2711-T9C1											
	2711-T9C1L1											
	2711-T9C10											
	2711-T9C10L1											
	2711-T9C14											
	2711-T9C14L1	DeviceNet										
2711-T9C12												
2711-T9C12L1	RS-232											
2711-T9C16												
2711-T9C16L1	RS-232 (DF1)											
2711-T9C15												
			640 x 480	Remote I/O								
				DeviceNet								
				RS-232								
				RS-232 (DF1)								
				ControlNet								

PanelView Standard 900 Terminals Secondary Replacement Options (Continued)

PanelView Standard Terminals						PanelView Plus 7 Terminals – Secondary Replacement Options						
Model	Cat. No.	Panel Cutout Dimensions		Display Resolution	Comm.	Cat. No.	Panel Cutout Dimensions		Display Resolution	Comm.	Adapter Kit Cat. No.	Notes
		Height mm (in.)	Width mm (in.)				Height mm (in.)	Width mm (in.)				
900	2711-T9C15L1	224 (8.80)	305 (12.00)	640 x 480	ControlNet	2711P-T10C21D85	224 (8.82)	269 (10.59)	800 x 600	One Ethernet port	N/A	PanelView Plus 7 Standard 10.4 in. terminal benefits: Higher resolution Application limits: • Max. screen count: 100 • Max. alarm messages: 500 • Max. number of controllers: 1 Communication = Ethernet (dual Ethernet ports are available). Operator input = only touch. Power input = only DC. Conformal coat = No.
	2711-T9C3				DH-485							
	2711-T9C3L1											
	2711-T9C9				RS-232 (DH-485)							
	2711-T9C9L1											
	2711-T9C8				DH+							
	2711-T9C8L1											
	2711-T9C20				Ethernet							
2711-T9C20L1												

PanelView Standard 1000 Terminals Conversions

See the tables in this section for primary and secondary conversions for PanelView Standard 1000 terminals.

PanelView Standard 1000 Terminals Primary Replacement Options

PanelView Standard Terminals					PanelView Plus 7 Terminals – Primary Replacement Options							
Model	Cat. No.	Panel Cutout Dimensions		Display Resolution	Comm.	Cat. No.	Panel Cutout Dimensions		Display Resolution	Comm.	Adapter Kit Cat. No.	Notes
		Height mm (in.)	Width mm (in.)				Height mm (in.)	Width mm (in.)				
1000	2711-K10C1	257 (10.11)	390 (15.35)	640 x 480	Remote I/O	2711P-T12W22A9P	218 (8.58)	312 (12.28)	1280 x 800	Dual Ethernet ports	2711P-RAAT12K	PanelView Plus 7 Performance 12.1 in. terminal benefits: • Wide screen has more usable screen area • Higher resolution • DLR Communication = Ethernet. Operator input = only touch. Power input = AC or DC ⁽¹⁾ Conformal coat = Yes ⁽²⁾ Adapter kit is necessary for drop-in replacement.
	2711P-T12W22D9P											
	2711-K10C1L1				2711P-T12W22A9P							
	2711-K10C10				DeviceNet	2711P-T12W22A9P						
	2711-K10C10L1					2711P-T12W22D9P						
	2711-K10C14					2711P-T12W22A9P						
	2711-K10C14L1				2711P-T12W22D9P							
	2711-K10C12				RS-232	2711P-T12W22A9P						
	2711-K10C12L1					2711P-T12W22D9P						
	2711-K10C16				RS-232 (DF1)	2711P-T12W22A9P						
	2711-K10C16L1					2711P-T12W22D9P						
	2711-K10C15				ControlNet	2711P-T12W22A9P						
	2711-K10C15L1					2711P-T12W22D9P						
	2711-K10C3				DH-485	2711P-T12W22A9P						
	2711-K10C3L1					2711P-T12W22D9P						
	2711-K10C9				RS-232 (DH-485)	2711P-T12W22A9P						
	2711-K10C9L1					2711P-T12W22D9P						
	2711-K10C8				DH+	2711P-T12W22A9P						
	2711-K10C8L1					2711P-T12W22D9P						
	2711-K10C20				Ethernet	2711P-T12W22A9P						
	2711-K10C20L1					2711P-T12W22D9P						
	2711-K10G1				Remote I/O	2711P-T12W22A9P						
	2711-K10G1L1					2711P-T12W22D9P						
	2711-K10G10				DeviceNet	2711P-T12W22A9P						
	2711-K10G10L1					2711P-T12W22D9P						
	2711-K10G14					2711P-T12W22A9P						
	2711-K10G14L1				2711P-T12W22D9P							
	2711-K10G12				RS-232	2711P-T12W22A9P						
	2711-K10G12L1					2711P-T12W22D9P						
	2711-K10G16				RS-232 (DF1)	2711P-T12W22A9P						
	2711-K10G16L1					2711P-T12W22D9P						
	2711-K10G15				ControlNet	2711P-T12W22A9P						
2711-K10G15L1	2711P-T12W22D9P											
2711-K10G3	DH-485	2711P-T12W22A9P										
2711-K10G3L1		2711P-T12W22D9P										

PanelView Standard 1000 Terminals Primary Replacement Options (Continued)

PanelView Standard Terminals					PanelView Plus 7 Terminals – Primary Replacement Options							
Model	Cat. No.	Panel Cutout Dimensions		Display Resolution	Comm.	Cat. No.	Panel Cutout Dimensions		Display Resolution	Comm.	Adapter Kit Cat. No.	Notes
		Height mm (in.)	Width mm (in.)				Height mm (in.)	Width mm (in.)				
1000	2711-K10G9	390 (15.35)		640 x 480	RS-232 (DH-485)	2711P-T12W22A9P	218 (8.58)	312 (12.28)	1280 x 800	Dual Ethernet ports	2711P- RAAT12K	PanelView Plus 7 Performance 12.1 in. terminal benefits: • Higher resolution • DLR Communication = Ethernet. Operator input = only touch. Power input = AC or DC. ⁽¹⁾ Conformal coat = Yes. ⁽²⁾ Adapter kit is necessary for drop-in replacement.
	2711-K10G9L1					2711P-T12W22D9P						
	2711-K10G8				2711P-T12W22A9P							
	2711-K10G8L1				2711P-T12W22D9P							
	2711-K10G20				2711P-T12W22A9P							
	2711-K10G20L1				2711P-T12W22D9P							
	2711-T10C1	257 (10.11)		640 x 480	Remote I/O	2711P-T12W22A9P						
	2711-T10C1L1				2711P-T12W22D9P							
	2711-T10C10				DeviceNet	2711P-T12W22A9P						
	2711-T10C10L1					2711P-T12W22D9P						
	2711-T10C14					2711P-T12W22A9P						
	2711-T10C14L1					2711P-T12W22D9P						
	2711-T10C12				RS-232	2711P-T12W22A9P						
	2711-T10C12L1				2711P-T12W22D9P							
	2711-T10C16				RS-232 (DF1)	2711P-T12W22A9P						
	2711-T10C16L1				2711P-T12W22D9P							
	2711-T10C15				ControlNet	2711P-T12W22A9P						
	2711-T10C15L1				2711P-T12W22D9P							
	2711-T10C3	338 (13.29)		640 x 480	DH-485	2711P-T12W22A9P						
	2711-T10C3L1				2711P-T12W22D9P							
	2711-T10C9				RS-232 (DH-485)	2711P-T12W22A9P						
	2711-T10C9L1				2711P-T12W22D9P							
	2711-T10C8				DH+	2711P-T12W22A9P						
	2711-T10C8L1				2711P-T12W22D9P							
	2711-T10C20				Ethernet	2711P-T12W22A9P						
	2711-T10C20L1					2711P-T12W22D9P						
	2711-T10G1				Remote I/O	2711P-T12W22A9P						
	2711-T10G1L1					2711P-T12W22D9P						
	2711-T10G10				DeviceNet	2711P-T12W22A9P						
	2711-T10G10L1					2711P-T12W22D9P						
	2711-T10G14					2711P-T12W22A9P						
	2711-T10G14L1					2711P-T12W22D9P						
	2711-T10G12				RS-232	2711P-T12W22A9P						
2711-T10G12L1	2711P-T12W22D9P											
2711-T10G16	RS-232 (DF1)				2711P-T12W22A9P							

PanelView Standard 1000 Terminals Primary Replacement Options (Continued)

PanelView Standard Terminals					PanelView Plus 7 Terminals – Primary Replacement Options							
Model	Cat. No.	Panel Cutout Dimensions		Display Resolution	Comm.	Cat. No.	Panel Cutout Dimensions		Display Resolution	Comm.	Adapter Kit Cat. No.	Notes
		Height mm (in.)	Width mm (in.)				Height mm (in.)	Width mm (in.)				
1000	2711-T10G16L1	257 (10.11)	338 (13.29)	640 x 480	RS-232 (DF1)	2711P-T12W22D9P	218 (8.58)	312 (12.28)	1280 x 800	Dual Ethernet ports	2711P-RAAT12	PanelView Plus 7 Performance 12.1 in. terminal benefits: • Higher resolution • DLR Communication = Ethernet. Operator input = only touch. Power input = AC or DC. ⁽¹⁾ Conformal coat = Yes. ⁽²⁾ Adapter kit is necessary for drop-in replacement.
	2711-T10G15				ControlNet	2711P-T12W22A9P						
	2711-T10G15L1				2711P-T12W22D9P							
	2711-T10G3				DH-485	2711P-T12W22A9P						
	2711-T10G3L1				2711P-T12W22D9P							
	2711-T10G9				RS-232 (DH-485)	2711P-T12W22A9P						
	2711-T10G9L1				2711P-T12W22D9P							
	2711-T10G8				DH+	2711P-T12W22A9P						
	2711-T10G8L1				2711P-T12W22D9P							
	2711-T10G20				Ethernet	2711P-T12W22A9P						
	2711-T10G20L1				2711P-T12W22D9P							

(1) AC power is only available on Series A terminals. DC power is only available on Series B terminals.

(2) Conformal coating is available for all DC-power, touch terminals. To order a terminal that is conformal-coated, add K to the end of a DC-power, touch catalog number; for example, 2711P-T12W22D9PK.

PanelView Standard 1000 Terminals Secondary Replacement Options

PanelView Standard Terminals						PanelView Plus 7 Terminals – Secondary Replacement Options						
Model	Cat. No.	Panel Cutout Dimensions		Display Resolution	Comm.	Cat. No.	Panel Cutout Dimensions		Display Resolution	Comm.	Adapter Kit Cat. No.	Notes
		Height mm (in.)	Width mm (in.)				Height mm (in.)	Width mm (in.)				
1000	2711-K10C1	257 (10.11)	390 (15.35)	640 x 480	Remote I/O	2711P-B15C22A9P	290 (11.42)	418 (16.46)	1024 x 768	Dual Ethernet ports	N/A	PanelView Plus 7 Performance 15 in. terminal benefits: <ul style="list-style-type: none"> • Wide screen has more usable screen area • Higher resolution • DLR Communication = Ethernet. Operator input = The 15 in. terminal is listed as secondary replacement if you require a keypad. Power input = AC or DC. ⁽¹⁾ Conformal coat = Yes ⁽²⁾
	2711P-B15C22D9P											
	DeviceNet				2711P-B15C22A9P							
					2711P-B15C22D9P							
					2711P-B15C22A9P							
					2711P-B15C22D9P							
	RS-232				2711P-B15C22A9P							
					2711P-B15C22D9P							
	RS-232 (DF1)				2711P-B15C22A9P							
					2711P-B15C22D9P							
	ControlNet				2711P-B15C22A9P							
					2711P-B15C22D9P							
	DH-485				2711P-B15C22A9P							
					2711P-B15C22D9P							
	RS-232 (DH-485)				2711P-B15C22A9P							
					2711P-B15C22D9P							
	DH+				2711P-B15C22A9P							
					2711P-B15C22D9P							
	Ethernet				2711P-B15C22A9P							
					2711P-B15C22D9P							
	Remote I/O				2711P-B15C22A9P							
					2711P-B15C22D9P							
	DeviceNet				2711P-B15C22A9P							
					2711P-B15C22D9P							
					2711P-B15C22A9P							
					2711P-B15C22D9P							
	RS-232				2711P-B15C22A9P							
					2711P-B15C22D9P							
	RS-232 (DF1)				2711P-B15C22A9P							
					2711P-B15C22D9P							
	ControlNet				2711P-B15C22A9P							
					2711P-B15C22D9P							
DH-485	2711P-B15C22A9P											
	2711P-B15C22D9P											

PanelView Standard 1000 Terminals Secondary Replacement Options (Continued)

PanelView Standard Terminals					PanelView Plus 7 Terminals – Secondary Replacement Options								
Model	Cat. No.	Panel Cutout Dimensions		Display Resolution	Comm.	Cat. No.	Panel Cutout Dimensions		Display Resolution	Comm.	Adapter Kit Cat. No.	Notes	
		Height mm (in.)	Width mm (in.)				Height mm (in.)	Width mm (in.)					
1000	2711-K10G9	390 (15.35)		640 x 480	RS-232 (DH-485)	2711P-B15C22A9P	290 (11.42)	418 (16.46)	1024 x 768	Dual Ethernet ports	N/A	PanelView Plus 7 Performance 15 in. terminal benefits: • Higher resolution • DLR Communication = Ethernet. Operator input = The 15 in. terminal is listed as secondary replacement if you require a keypad. Power input = AC or DC ⁽¹⁾ Conformal coat = Yes ⁽²⁾	
	2711-K10G9L1				2711P-B15C22D9P								
	2711-K10G8				2711P-B15C22A9P								
	2711-K10G8L1				2711P-B15C22D9P								
	2711-K10G20				2711P-B15C22A9P								
	2711-K10G20L1				2711P-B15C22D9P								
	2711-T10C1	257 (10.11)		640 x 480	Remote I/O	No secondary option available.							
	2711-T10C1L1												
	2711-T10C10				DeviceNet								
	2711-T10C10L1												
	2711-T10C14												
	2711-T10C14L1												
	2711-T10C12				RS-232								
	2711-T10C12L1												
	2711-T10C16				RS-232 (DF1)								
	2711-T10C16L1												
	2711-T10C15				ControlNet								
	2711-T10C15L1												
	2711-T10C3				DH-485								
	2711-T10C3L1												
	2711-T10C9				RS-232 (DH-485)								
	2711-T10C9L1												
	2711-T10C8				DH+								
	2711-T10C8L1												
	2711-T10C20				Ethernet								
	2711-T10C20L1												
	2711-T10G1				Remote I/O								
	2711-T10G1L1												
	2711-T10G10												DeviceNet
	2711-T10G10L1												
	2711-T10G14												
	2711-T10G14L1	RS-232											
	2711-T10G12												
2711-T10G12L1													
2711-T10G16	RS-232 (DF1)												

PanelView Standard 1000 Terminals Secondary Replacement Options (Continued)

PanelView Standard Terminals					PanelView Plus 7 Terminals – Secondary Replacement Options							
Model	Cat. No.	Panel Cutout Dimensions		Display Resolution	Comm.	Cat. No.	Panel Cutout Dimensions		Display Resolution	Comm.	Adapter Kit Cat. No.	Notes
		Height mm (in.)	Width mm (in.)				Height mm (in.)	Width mm (in.)				
1000	2711-T10G16L1	257 (10.11)	338 (13.29)	640 x 480	RS-232 (DF1)							No secondary option available.
	2711-T10G15				ControlNet							
	2711-T10G15L1											
	2711-T10G3				DH-485							
	2711-T10G3L1											
	2711-T10G9				RS-232 (DH-485)							
	2711-T10G9L1											
	2711-T10G8				DH+							
	2711-T10G8L1											
	2711-T10G20				Ethernet							
	2711-T10G20L1											

(1) AC power is only available on Series A terminals. DC power is only available on Series B terminals.

(2) Conformal coating is available for the DC power, 15 in. combination keypad/touch terminals. To order a terminal that is conformal-coated, add K to the end of a DC-power catalog number; for example, 2711P-B15C22D9PK.

PanelView Standard 1400 Terminals Conversions

See the tables in this section for primary and secondary conversions for PanelView Standard 1400 terminals.

PanelView Standard 1400 Terminals Primary Replacement Options

PanelView Standard Terminals						PanelView Plus 7 Terminals – Primary Replacement Options						
Model	Cat. No.	Panel Cutout Dimensions		Display Resolution	Comm.	Cat. No.	Panel Cutout Dimensions		Display Resolution	Comm.	Adapter Kit Cat. No.	Notes
		Height mm (in.)	Width mm (in.)				Height mm (in.)	Width mm (in.)				
1400	2711-T14C1	305 (12.00)	391 (15.40)	800 x 600	Remote I/O	2711P-T15C22A9P	290 (11.42)	353 (13.9)	1024 x 768	Dual Ethernet ports	2711P-RAAT15	PanelView Plus 7 Performance 15 in. terminal benefits: • Higher resolution • DLR Communication = Ethernet. Operator input = only touch. Power input = only AC. Conformal coat = No. Adapter kit is necessary for drop-in replacement.
	2711-T14C14				DeviceNet							
	2711-T14C10				RS-232							
	2711-T14C12				RS-232 (DF1)							
	2711-T14C16				ControlNet							
	2711-T14C15				DH-485							
	2711-T14C3				RS-232 (DH-485)							
	2711-T14C9				DH+							
	2711-T14C8				Ethernet							
	2711-T14C20				Ethernet							
	2711-K14C1	419 (16.50)	800 x 600	Remote I/O	2711P-B15C22A9P	418 (16.46)	1024 x 768	Dual Ethernet ports	2711P-RAAK15	PanelView Plus 7 Performance 15 in. terminal benefits: • Higher resolution • DLR Communication = Ethernet. Operator input = keypad and touch. Power input = only AC. Conformal coat = No. Adapter kit is necessary for drop-in replacement.		
	2711-K14C14			DeviceNet								
	2711-K14C10			RS-232								
	2711-K14C12			RS-232 (DF1)								
	2711-K14C16			ControlNet								
	2711-K14C15			DH-485								
	2711-K14C3			RS-232 (DH-485)								
	2711-K14C9			DH+								
	2711-K14C8			Ethernet								
	2711-K14C20			Ethernet								

PanelView Standard 1400 Terminals Secondary Replacement Options

PanelView Standard Terminals						PanelView Plus 7 Terminals – Secondary Replacement Options						
Model	Cat. No.	Panel Cutout Dimensions		Display Resolution	Comm.	Cat. No.	Panel Cutout Dimensions		Display Resolution	Comm.	Adapter Kit Cat. No.	Notes
		Height mm (in.)	Width mm (in.)				Height mm (in.)	Width mm (in.)				
1400	2711-T14C1	305 (12.00)	391 (15.40)	800 x 600	Remote I/O	2711P-T15C21D8S	290 (11.42)	353 (13.90)	1024 x 768	One Ethernet port	N/A	PanelView Plus 7 Standard 15 in. terminal benefits: Higher resolution Application limits: • Max. screen count: 100 • Max. alarm messages: 500 • Max. number of controllers: 1 Communication = Ethernet (dual Ethernet ports are available). Operator input = only touch. Power input = only DC. Conformal coat = No.
	2711-T14C14				DeviceNet							
	2711-T14C10											
	2711-T14C12				RS-232							
	2711-T14C16				RS-232 (DF1)							
	2711-T14C15				ControlNet							
	2711-T14C3				DH-485							
	2711-T14C9				RS-232 (DH-485)							
	2711-T14C8				DH+							
	2711-T14C20				Ethernet							
	2711-K14C1	Remote I/O	419 (16.50)	800 x 600	Remote I/O							
	2711-K14C14	DeviceNet										
	2711-K14C10											
	2711-K14C12	RS-232										
	2711-K14C16	RS-232 (DF1)										
	2711-K14C15	ControlNet										
	2711-K14C3	DH-485										
	2711-K14C9	RS-232 (DH-485)										
	2711-K14C8	DH+										
	2711-K14C20	Ethernet										

PanelView Enhanced 1000e, 1200e, 1400e Terminals Conversions

See the tables in this section for primary and secondary conversions for PanelView Enhanced 1000e, 1200e, 1400e terminals.

PanelView Enhanced 1000e, 1200e, 1400e Terminals Primary Replacement Options

PanelView Standard Terminals						PanelView Plus 7 Terminals – Primary Replacement Options							
Model	Cat. No.	Panel Cutout Dimensions		Display Resolution	Comm.	Cat. No.	Panel Cutout Dimensions		Display Resolution	Comm.	Adapter Kit Cat. No.	Notes	
		Height mm (in.)	Width mm (in.)				Height mm (in.)	Width mm (in.)					
1000e	2711E-K10C15	257 (10.11)	390 (15.35)	640 x 480	ControlNet	2711P-T12W22A9P	218 (8.58)	312 (12.28)	1280 x 800	Dual Ethernet ports	2711P-RAAT12K (keyboard)	PanelView Plus 7 Performance 12.1 in. terminals benefits: • Wide screen has more usable screen area • Higher resolution • DLR	
	2711E-K10C6		338 (13.29)		Remote I/O								2711P-RAAT12 (touch)
	2711E-T10C15				ControlNet								
	2711E-T10C6				Remote I/O								
1200e	2711E-K12C6	326 (12.85)	429 (16.90)	800 x 600	Remote I/O	2711P-T12W22A9P	218 (8.58)	312 (12.28)	1280 x 800	Dual Ethernet ports	N/A	Communication = Ethernet. Operator input = only touch. Power input = AC. Conformal coat = No. Adapter kit is necessary for drop-in replacement for 1000e terminals.	
	2711E-T12C4	316 (12.50)	318 (12.50)		RS-232								
1400e	2711E-K14C15	326.40 (12.85)	429.30 (16.90)	800 x 600	ControlNet	2711P-B15C22A9P	290 (11.42)	353 (13.9)	1024 x 768	Dual Ethernet ports	2711P-RAAK15	PanelView Plus 7 Performance 15 in. terminal benefits: • Higher resolution • DLR Communication = Ethernet. Operator input = keypad and touch. Power input = AC. Conformal coat = No. Adapter kit is necessary for drop-in replacement.	
	2711E-K14C6				Remote I/O								2711P-RAAT15
	2711E-T14C15		390.50 (15.38)		ControlNet								
	2711E-T14C6				Remote I/O	2711P-T15C22A9P		418 (16.46)					

PanelView Enhanced 1000e, 1200e, 1400e Terminals Secondary Replacement Options

PanelView Standard Terminals						PanelView Plus 7 Terminals – Secondary Replacement Options												
Model	Cat. No.	Panel Cutout Dimensions		Display Resolution	Comm.	Cat. No.	Panel Cutout Dimensions		Display Resolution	Comm.	Adapter Kit Cat. No.	Notes						
		Height mm (in.)	Width mm (in.)				Height mm (in.)	Width mm (in.)										
1000e	2711E-K10C15	257 (10.11)	390 (15.35)	640 x 480	ControlNet	2711P-B15C22A9P	290 (11.42)	418 (16.46)	1024 x 768	Dual Ethernet ports	N/A	PanelView Plus 7 Performance 15 in. terminal benefits: • Higher resolution • DLR Communication = Ethernet. Operator input = Keypad and touch. Power input = AC. Conformal coat = No.						
	2711E-K10C6		338 (13.29)		Remote I/O								No secondary option available.					
	2711E-T10C15				ControlNet													
	2711E-T10C6				Remote I/O													
1200e	2711E-K12C6	326 (12.85)	429 (16.90)	800 x 600	Remote I/O	2711P-B15C22A9P	290 (11.42)	418 (16.46)	1024 x 768	Dual Ethernet ports	N/A							
	2711E-T12C4	316 (12.50)	318 (12.50)		RS-232								No secondary option available.					
1400e	2711E-K14C15	326.40 (12.85)	429.30 (16.90)	800 x 600	ControlNet	2711P-T15C21D8S	290 (11.42)	353 (13.90)	1024 x 768	One Ethernet port	N/A	PanelView Plus 7 Standard 15 in. terminal benefits: Higher resolution Application limits: • Max. screen count: 100 • Max. alarm messages: 500 • Max. number of controllers: 1 Communication = Ethernet (dual Ethernet ports are available). Operator input = only touch. Power input = only DC. Conformal coat = No.						
	2711E-K14C6		390.50 (15.38)		Remote I/O													
	2711E-T14C15				ControlNet													
	2711E-T14C6				Remote I/O													

Accessories

Some accessories and accessory catalog numbers are new or have changed for PanelView Plus 7 Standard and PanelView Plus 7 Performance terminals. See the accessories section in the respective user manuals that are listed in [Additional Resources on page 127](#) for a list of accessories and catalog numbers for the terminals.

Legacy Communication Support

PanelView Plus 7 terminals use only Ethernet communication. If you need support for non-Ethernet communication protocols, go to the following Encompass™ Partner websites:

- <http://www.anybus.com/products/prodindex.shtml>
- <http://www.prosoft-technology.com/Products/Gateways>

Adapter Kit Conversion Table

The adapter kit provides hardware for installing a PanelView Plus 7 Performance terminal into the cutout of the existing PanelView terminal. See the Adapter Kit for PanelView 5500 and PanelView Plus 7 Performance Terminals, publication [VIEW-IN0002](#).

IMPORTANT These adapter kits are for PanelView Plus 7 Performance terminals.

Do not install a PanelView Plus 7 Standard terminal with these adapter kits. The bezel of the standard terminal can be damaged, which can reduce the effectiveness of the seal and damage the terminal and components that are installed in the cabinet.

Adapter Kit Cat. No.	Replace this Existing PanelView Standard or PanelView Enhanced Terminal...	With this PanelView Plus 7 Performance Terminal
2711P-RAAT7	N/A	6.5 in. touch screen
2711P-RAAK7	600 terminal, keypad, or keypad with touch screen	6.5 in. keypad with touch screen
2711P-RAAT10	900 terminal, touch screen	10.4 in. touch screen
2711P-RAAK10	900 terminal, keypad	10.4 in. keypad with touch screen
2711P-RAAT12	1000 and 1000e terminals, touch screen	12.1 in. touch screen
2711P-RAAT12K	1000 and 1000e terminals, keypad	12.1 in. touch screen
2711P-RAAT15	1400 and 1400e terminals, touch screen	15 in. touch screen
2711P-RAAK15	1400 and 1400e terminals, keypad	15 in. keypad with touch screen

Function Key Comparisons

Table 2 - PanelView Plus Replacement Terminals

PanelView Standard Terminal	PanelView Plus 7 Replacement Terminal	Adapter Kit Required	Adapter Kit Cat. No.
PanelView Standard 300 or 300 Micro	None ⁽¹⁾	—	—
PanelView 550 or 600 touch	PanelView Plus 400 keypad or keypad/touch PanelView Plus 600 touch	No	—
PanelView 550 keypad PanelView 550 keypad/ touch	PanelView Plus 600 keypad or keypad/touch	No	—
	PanelView Plus 400 keypad or keypad/touch PanelView Plus 600 touch	Yes	2711P-RAK4
PanelView 600 keypad PanelView 600 keypad/ touch	PanelView Plus 600 keypad or keypad/touch	Yes	2711P-RAK6
	PanelView Plus 700 keypad or keypad/touch	No	—
PanelView 900 keypad	PanelView Plus 700 keypad or keypad/touch	Yes	2711P-RAK7
	PanelView Plus 1000 keypad or keypad/touch	No	—
PanelView 900 touch	PanelView Plus 700 touch	Yes	2711P-RAT7
	PanelView Plus 1000 touch	No	—
PanelView 1000 keypad	PanelView Plus 1000 keypad or keypad/touch	Yes	2711P-RAK10
	PanelView Plus 1250 keypad or keypad/touch	No	—
PanelView 1000 touch	PanelView Plus 1000 touch	Yes	2711P-RAT10
	PanelView Plus 1250 touch	No	—
PanelView 1400 keypad	PanelView Plus 1250 keypad or keypad/touch	Yes	2711P-RAK12S
	PanelView Plus 1500 keypad or keypad/touch	No	—
PanelView 1400 touch	PanelView Plus 1250 touch	Yes	2711P-RAT12S
	PanelView Plus 1500 touch	No	—

(1) You can replace the PanelView Standard 300 or 300 Micro with a PanelView Plus 400 keypad terminal by increasing the size of the current panel cutout.

The table provides a comparison of function keys between the PanelView Standard and PanelView Plus 7 terminals.

Table 3 - Function Key Comparisons Between Terminal Platforms

PanelView Standard Keypad or Keypad/Touch	PanelView Standard Function Keys	PanelView Plus 7 Function Keys	PanelView Plus 7 Terminal Keypad or Keypad/Touch
300M keypad	F1...F4		
300 keypad	F1...F8	F1...F8	400 keypad or keypad/touch
550 keypad or keypad/touch	F1...F10	F1...F10	600 keypad or keypad/touch
600 keypad or keypad/touch	F1...F10	F1...F10, K1...K12	700 keypad or keypad/touch
900 keypad	F1...F16	F1...F16, K1...K16	1000 keypad or keypad/touch
1000 keypad	F1...F16	F1...F20, K1...K20	1250 keypad or keypad/touch
1400 keypad	F1...F16, F17...F21	F1...F20, K1...K20	1500 keypad

Installing a PanelView Plus 7 Terminal

Optionally install the selected PanelView Plus 7 terminal into the existing PanelView Standard panel cutout. You may need an adapter kit depending on your terminal selection.

TIP You can install the terminal after converting and testing your application.

Refer to [Additional Resources on page 127](#) for a list of applicable documentation for your terminal replacement and adapter kit , if necessary.

Import Your Application

Introduction

In this chapter, you import your existing PanelBuilder®32 application into FactoryTalk® View Machine Edition (ME) software.

Different software is used by the PanelView™ Standard and PanelView Plus 7 platforms to develop applications.

- PanelView Standard terminals run applications that are created with PanelBuilder32 software.
- PanelView Plus 7 terminals run applications that are created with FactoryTalk View ME software.

Before You Begin

- Review the migration considerations (Chapter 1).
- Select a PanelView Plus 7 terminal replacement and adapter kit, if necessary (Chapter 2).
- Optionally install the PanelView Plus 7 terminal replacement (Chapter 2). You can install the terminal after migrating and testing your application.

What You Need

- FactoryTalk View Studio for Machine Edition software with correct version for your PanelView Plus 7 terminal. Refer to [Required Software on page 6](#) for details.
- PanelBuilder32 .pba application file.

The application file can reside on your local hard disk drive or external storage media:

- Secure Digital (SD) card or USB flash drive for PanelView Plus 7 terminals.
- USB flash drive for PanelView Plus 7.

Follow These Steps

Follow these steps to import your PanelBuilder32 application into FactoryTalk View Machine Edition software.

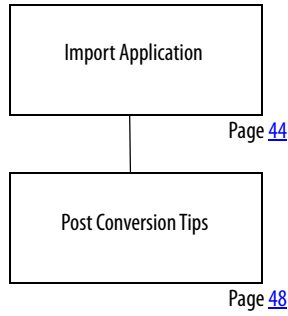

Import Application

Follow these steps to import a PanelBuilder32 application into FactoryTalk View Machine Edition software.

1. Launch the FactoryTalk View Studio software.

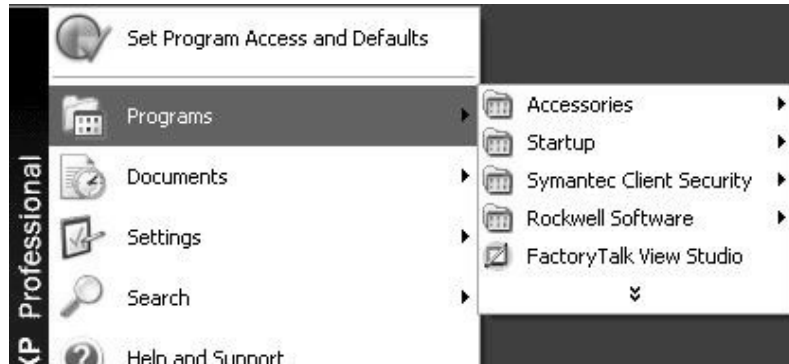

2. Click the New tab.

3. Enter an Application name and click Import.

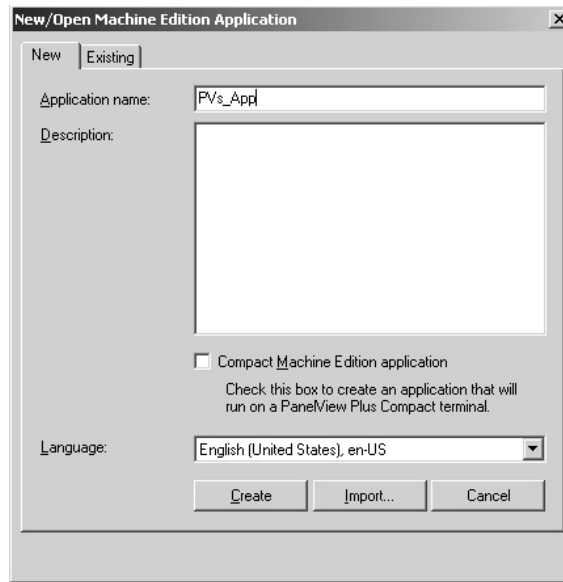

4. Read the FactoryTalk View dialog box and click OK.

RSLinx® Enterprise software for FactoryTalk View does not need to be installed before you import your PanelBuilder32 application.

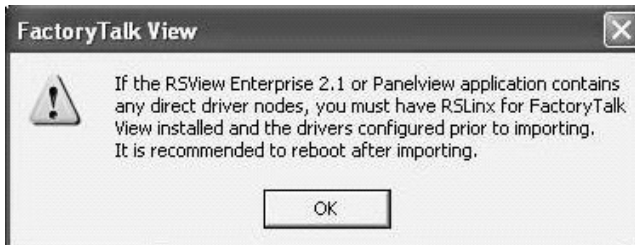

5. Select PanelBuilder Application (*.pba) and click Next.

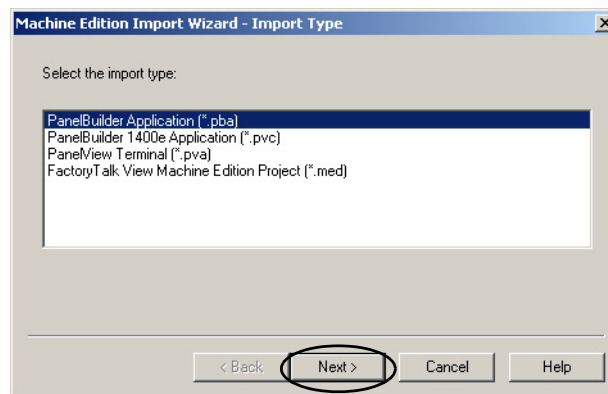

6. Select PanelView Terminal (*.pva) if you don't have the corresponding .pba file.

7. Click the ... button.

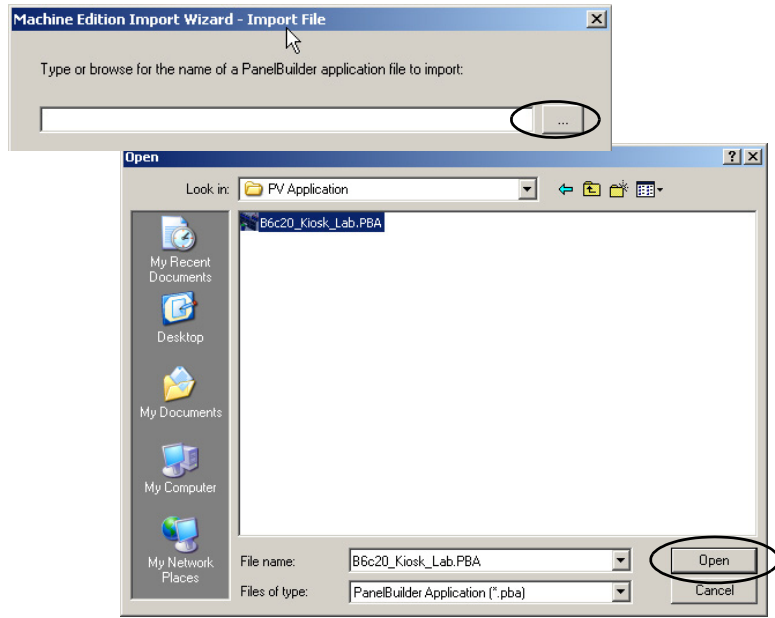

8. Browse to and select your PanelBuilder32 .pba application and click Open.

The .pba or .pva file can reside on your local hard disk drive or external storage appropriate to your terminal.

9. Click Next.

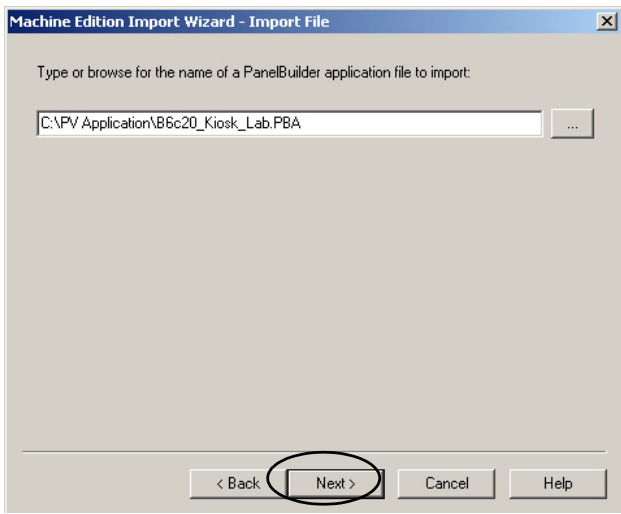

10. Configure the import options that are based on your replacement terminal.

Click Help at any time for clarification of each option.

- Check the Convert to new window size checkbox.
- Select the size (in pixels) of your PanelView Plus 7 terminal display as shown in the chart.

Panelview Plus 7 Terminal	Resolution (pixels)
PanelView Plus 7 Standard 4 in. (wide)	480 x 272
PanelView Plus 7 Standard 6 in.	640 x 480
PanelView Plus 7 Standard 7 in. PanelView Plus 7 Performance 7 in.	640 x 480
PanelView Plus 7 Standard 9 in. PanelView Plus 7 Performance 9 in. (wide)	800 x 480
PanelView Plus 7 Standard 10 in. PanelView Plus 7 Performance 10 in.	800 x 600
PanelView Plus 7 Standard 12 in. PanelView Plus 7 Performance 12 in. (wide)	1280 x 800
PanelView Plus 7 Standard 15 in. PanelView Plus 7 Performance 15 in.	1024 x 768
PanelView Plus 7 Standard 19 in. PanelView Plus 7 Performance 19 in.	1280 x 1024

- Check Scale graphic displays.
- When checked, this setting rescales all displays.
- If your original PanelView Standard terminal had a touch screen, or both a touch screen and keypad, check the box under Touch property conversion.
- Click the Help button to read the differences between the caption alignment options, then select an option for your new application.
- Click Finish.

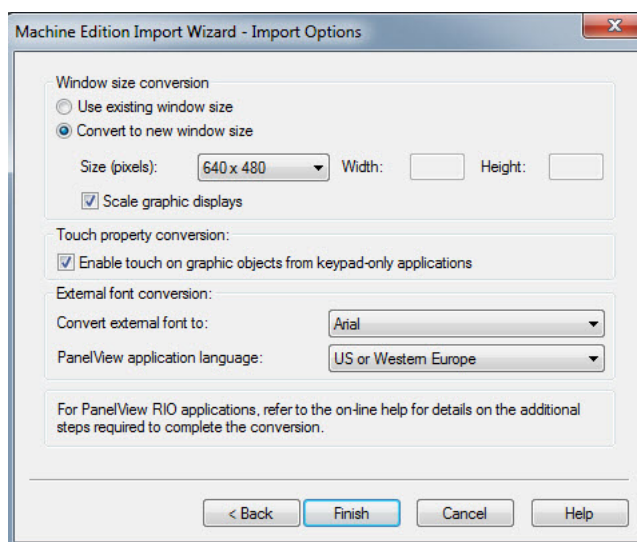

The Importing Project dialog box shows the conversion status. This process may take a while, depending on the size of your application. When done, you will see the Project Status dialog box in the next step.

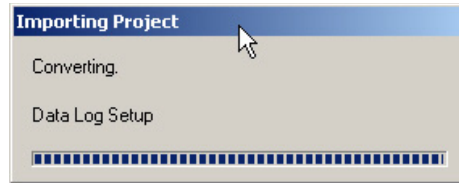

11. Review the Project Status dialog box and click OK.

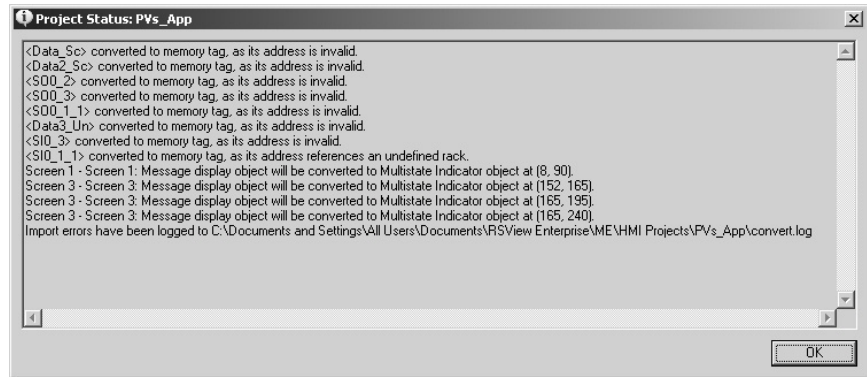

12. Repeat steps 1...11 for each PanelBuilder32 application you want to import into FactoryTalk View ME software.

Post Conversion Tips

This table lists topics to consider after importing an application.

Table 4 - Post Conversion Tips

Software Feature	Description	What You Need To Do
Logout button	A Logout button that is assigned to a function key in a PanelBuilder32 project that does not convert properly in the Machine Edition application.	Reassign the function key manually.
Device shortcuts	After importing a PanelBuilder32 .pba project, you may not see the newly created device shortcuts in the Tag Browser.	Restart FactoryTalk View Studio software. When you reopen the imported application, the shortcuts display correctly.
Screens	When you import PanelBuilder32 projects, all screens are minimized.	Nothing
Multistate objects	The first state value of PanelBuilder32 multistate objects is 1. In Machine Edition software, the first state value of multistate objects is 0.	If the imported application contains any of these multistate objects, verify the state values: <ul style="list-style-type: none"> Control list selector List indicator Multistate indicator Latched push button Maintained push button Momentary push button Multistate push button Symbol indicator

Review the Application Conversion Log

Introduction

In this chapter, you review the conversion log generated by FactoryTalk® View Machine Edition (ME) software for your imported application. The results of this log help you to determine what updates are required in your converted application.

Before You Begin

- Review migration considerations (Chapter 1).
- Select a PanelView™ Plus 7 terminal replacement and adapter kit, if necessary (Chapter 2).
- Install the PanelView Plus 7 terminal in the existing PanelView Standard panel cutout (Chapter 2).
- Import your PanelBuilder®32 .pba application into FactoryTalk View ME software (Chapter 3).

What You Need

- The new name of the application that was imported into FactoryTalk View ME software. This action was completed in Chapter 3.
- Conversion log, `convert.log`, generated by the FactoryTalk View ME import wizard.

Follow These Steps

Follow this path to review changes that are required to your FactoryTalk View ME application.

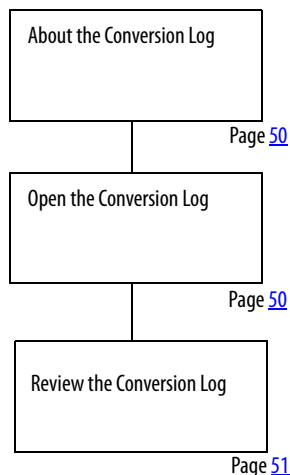

About the Conversion Log

The application conversion log, `convert.log`, is generated by the import wizard when you import your PanelBuilder32 application into FactoryTalk View ME software. This log provides detailed information about objects or features that did not convert directly from your PanelBuilder32 application. Use this log as a guide to update your application accordingly. Modifications to the application are required to verify that the application operates correctly in FactoryTalk View ME software.

IMPORTANT It is important that you review each object and feature in the converted application to verify that they function as expected. Because PanelBuilder32 objects or features may not map directly into FactoryTalk View ME software, you may need to update your ladder logic to achieve the same operational results.

Open the Conversion Log

The conversion log, `convert.log`, is stored with the new application that was imported into FactoryTalk View ME software.

Follow these steps to locate the conversion log on your computer.

1. Navigate to this folder.

C:\Documents and Settings\All Users\Documents\RSView
Enterprise\ME\HMI projects\

TIP All of your FactoryTalk View ME applications are located in this folder. This includes new or imported applications.

2. Double-click the HMI project folder that contains the new application name you created.

You entered this name in the import wizard when importing your PanelBuilder32 application into FactoryTalk View ME software.

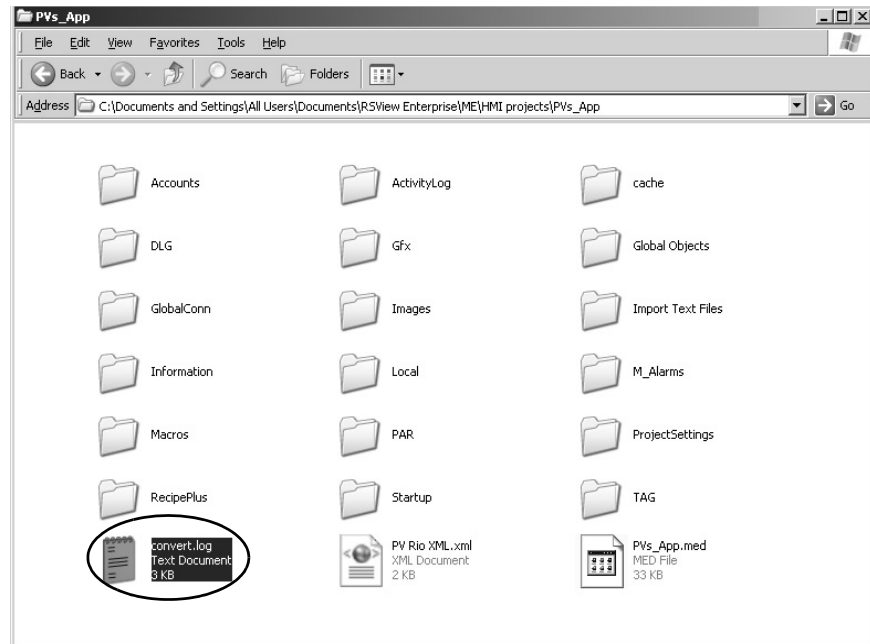

3. Double-click the convert.log file that is generated by the import wizard.

Your convert.log file varies from the example shown.

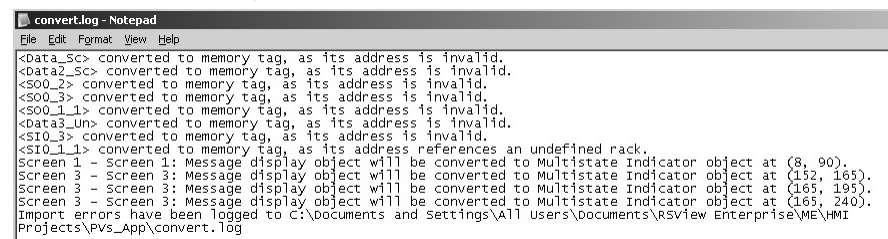

Review the Conversion Log

The conversion log file, convert.log, contains a list of messages including warnings, errors, and unsupported features or objects in the converted application. You can compare these messages to the messages in the tables for information on why the message was logged. For your convenience, the message tables are categorized into these groups:

- RSLinx® software
- Tags
- Objects and screens
- Alarms

When resolving conversion log messages, refer to your original PanelBuilder32 application to review how the objects and tags were used.

During conversion, all PanelBuilder32 tag names and addresses are converted to HMI tags in the FactoryTalk View ME tag database.

IMPORTANT Some features or objects are no longer supported in FactoryTalk View ME software. However, new features or objects are available providing the same or enhanced functionality.

Conversion Messages You Can Ignore

Some error messages appear consistently when importing PanelBuilder32 projects and can be ignored.

Table 5 - Conversion Messages: To Be Ignored

Error Type	Ignore this Error
Startup editor	The initial screen does not exist in the graphics list.
Startup editor	Failed to get startup information.
Format error	File c:\documents and settings\all users\documents\rsview enterprise\me\hmi project\app1\import text files\almsg.txt, section/key 'main'
Tags	Tags with a bit data type and a scale value of 0 are incorrectly logged during the import.
Scale errors	Tag scale errors are logged only for analog tags.

RSLinx Messages

This table lists RSLinx messages that may appear in the convert.log file.

Table 6 - Conversion Log Messages: RSLinx Software

Message	Description
RSLinx Topic Converter log file that is created on <date> at <time>. RSLinx2X topics to RSLinx Enterprise shortcuts conversion failed. You must manually convert topics to shortcuts.	Review the HMI tags in FactoryTalk View ME software and note the shortcut name. It is the same as the controller name in the PanelBuilder32 application. You must use this name when creating the shortcut in FactoryTalk View ME software. For information on creating shortcuts, refer to: <ul style="list-style-type: none"> FactoryTalk View Machine Edition User Guide, Volume 1, publication ViewME-UM004, for details on creating shortcuts. Videos at http://www.rockwellautomation.com/solutions/integratedarchitecture/resources4.html
RSLinx is not installed. Install the latest RSLinx software for proper import. Cannot create instance of RSLinx. Topic generation does not succeed.	In FactoryTalk View ME software, configure communication and create a shortcut.

Screen and Object Conversion Messages

Table 19 lists screen and object messages that may appear in the convert.log file. Most of the messages identify these attributes for a FactoryTalk View ME object:

- Screen number and name
- Location (x,y) of the object
- New graphic object name

Use this information to locate the object and make required modifications. The description for a message may reference a workaround in this document.

Here are some general notes on object conversions:

- Numeric display objects in PanelBuilder32 software are converted to Text objects with embedded variables in FactoryTalk View ME software.
- A Numeric Input Enable button in FactoryTalk View ME software does not have a separate display tag. The display value is converted to an embedded variable on the Label Tab.
- The Numeric Input Cursor object in FactoryTalk View ME software has a separate indicator tag and does not have a Label tab for text.

Table 7 - Conversion Log Messages: Screens and Objects

Message	Description
Message display object is converted to Multistate Indicator object at <location>.	A message display in PanelBuilder32 software is the same as a multistate indicator in FactoryTalk View ME software.
Verify password button at <location> not supported.	The Verify Password button is not supported in FactoryTalk View ME software.
Select Operator button at <location> not supported.	The Select Operator button is not supported in FactoryTalk View ME software.
Screen security settings not converted.	Security settings are not converted in FactoryTalk View ME software. You must reconfigure all security settings.
String popup is invoked with blank scratchpad on <location>.	Verify operation in FactoryTalk View ME software.
Cannot find block write start tag for pilot list selector at <location>. The visible state connection is unassigned.	The Piloted Control List Selector in PanelBuilder32 software does not have a block write tag assigned. Assign a block write tag in FactoryTalk View ME software if you want a visible state connection.
For LSB support, refer to online help for correct syntax of Multistate Indicator's Value control at <location>.	FactoryTalk View ME software does support Least Significant Bit (LSB) on multistate and list indicators. Check the object and make sure that the syntax is correct for the value. The L parameter is used only for message addresses that are more than one word in length. See the FactoryTalk View online help for information on the L parameter.
Blinking color images are not supported.	FactoryTalk View ME software does not support blinking color images.
Print Only objects not supported.	FactoryTalk View ME software does not support Print Only objects.
Line at <location> could not have property set: Width.	In FactoryTalk View ME software, lines have a line width that is separate from the object location.
Line at <location> could not have property set: Height.	In FactoryTalk View ME software, lines have a line height that is separate from the object location.
Numeric entry enable button at <location> could not have property set: Minimum Value. Numeric entry enable button at <location> could not have property set: Maximum Value.	The Numeric Entry Enable button is converted to a Numeric Input Enable button in FactoryTalk View ME software. <ul style="list-style-type: none"> In PanelBuilder32 software, the input and display floating point tags shared name and address. The min/max values were out of range and could not be set in the FactoryTalk View ME object. In FactoryTalk View ME software, set the default min and max for floating point. The display value is an embedded variable on the Label tab.

Tag Conversion Messages

This table lists tag messages that may appear in the convert.log file.

Table 8 - Conversion Log Messages: Tags

Message	Description
Invalid characters not supported. Tag has been converted to <name>.	FactoryTalk View ME software does not support periods in tag names. The periods are converted to underscores.
Already exists in the tag database.	The converted tag already exists in the FactoryTalk View ME HMI tag database or the conversion created it.
Could not be added to the tag database.	Verify that all tag names exist in the FactoryTalk View HMI tag database after the conversion.
The minimum value for this tag was invalid and has been set to the minimum value based on the tag's data type.	The minimum value for the tag in the PanelBuilder32 application is not valid in the FactoryTalk View ME application. This discrepancy was corrected. The minimum value for the tag was set according to the tag's data type. Verify that the tag data type and minimum value are correct.
The maximum value for this tag was invalid and has been set to the minimum valid value based on the tag's data type.	The maximum value for the tag in the PanelBuilder32 application is not valid in the FactoryTalk View ME application. This discrepancy was corrected. The maximum value for the tag was set according to the tag's data type. Verify that the tag data type and maximum value are correct.
The scale for this tag was invalid and has been set to its default value.	Verify that the scale for the tag data type is correct.
Tag converted to memory tag, as its addressing syntax is not supported.	For this specific instance, an RIO bit array data type with a length of 2 is using output O:xxx address. In the converted application, FactoryTalk View ME software does not support bit arrays. Bit arrays are converted to memory tags.
Tag converted to memory tag, as its address is blank.	The tag was converted to a memory tag because the tag address was blank in the PanelBuilder32 software.
The array size for this tag was invalid and has been set to the maximum supported size.	The character array size was converted to the maximum string length of 82 in the FactoryTalk View ME application.
Bit array tags are not supported. Tag will be converted as a memory tag.	FactoryTalk View ME software does not support the bit array data type. Typically, bit arrays were used in PanelBuilder32 software for addresses less than one word in length. In FactoryTalk View ME software, change the tag address to a full word address. When you use non-Remote I/O addresses, these conversions take place: <ul style="list-style-type: none"> • Bit array is converted to an analog, default type Device tag with a word length as opposed to a memory tag. • BOOL is converted to a bit tag. • DINT is converted to an analog, long integer tag.

Alarm Conversion Messages

This table lists alarm messages that may appear in the convert.log file.

For optimal performance, convert PanelBuilder32 alarm tags to direct reference tags in FactoryTalk View ME software. Use the L parameter for the length in 16-bit words. The alarm trigger type can be bit.

See the FactoryTalk View online help for information on the word length L parameter.

Table 9 - Conversion Log Messages: Alarms

Message	Description
Bit and LSBit triggered alarms that used a trigger tag with a bit data type will only be able to trigger a single alarm after import.	See Alarm Trigger Tags on page 8 for details on alarm tag data types.
Alarm message Ack option not supported.	In PanelBuilder32 software, the alarm ACK is on an individual message. FactoryTalk View ME software does not support individual acknowledgement of alarms. The alarm Ack is on the triggers.
Alarm List at <location> displays all alarms.	This message describes the type of alarm list.
Alarm List at <location> displays all active alarms.	This message describes the type of alarm list.
Alarm List at <location> will display all alarms that have come out of alarm.	This message describes the type of alarm list.
Alarm List at <location> does not support displaying alarms that do not require acknowledgement.	This message describes the type of alarm list.
"Remote Clear All Alarm Tag" alarm control not supported.	FactoryTalk View ME software does not support this alarm tag.
"Remote Clear All Alarm Handshake Tag" alarm control not supported.	FactoryTalk View ME software does not support this alarm tag.
Tag converted to memory tag, as its address is blank.	The tag was converted to a memory tag because the tag address was blank in PanelBuilder32 software.
The array size for this tag was invalid and has been set to the maximum supported size.	The character array size was converted to the maximum string length of 82.
Bit array tags are not supported. Tag will be converted as a memory tag.	<p>FactoryTalk View ME software does not support the bit array data type. Typically, bit arrays were used in PanelBuilder32 software for addresses less than one word in length.</p> <p>In FactoryTalk View ME software, change the tag address to a full word address. When using non-Remote I/O addresses, these conversions take place:</p> <ul style="list-style-type: none"> • Bit array is converted to an analog, default type device tag with a word length as opposed to a memory tag. • BOOL is converted to a bit tag. • DINT is converted to an analog, long integer tag.

Review Object Mapping

Introduction

In this chapter, you review how objects and alarms from PanelBuilder®32 software map to FactoryTalk® View Machine Edition (ME) software.

Before You Begin

- Review migration considerations (Chapter 1).
- Select a PanelView™ Plus 7 terminal replacement and adapter kit, if necessary (Chapter 2).
- Optionally install the PanelView Plus 7 terminal in the existing PanelView Standard panel cutout (Chapter 2).
- Import your PanelBuilder32 .pba application into FactoryTalk View ME software (Chapter 3).
- Review the conversion log for your imported application (Chapter 4).

What You Need

Conversion log generated by the FactoryTalk View ME Import Wizard for the imported application.

Follow These Steps

Follow these steps to review how PanelBuilder32 objects and alarms map to FactoryTalk View ME software. This information helps you correct application errors that are listed in the conversion log.

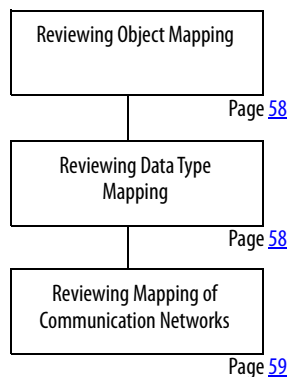

Reviewing Object Mapping

This table identifies how some PanelBuilder32 graphic objects migrate into a FactoryTalk View ME application.

IMPORTANT It is important that you verify the function of all objects after importing your application to FactoryTalk View ME software. New objects may not function as expected.

Table 10 - Object Mapping

This PanelBuilder32 object	Maps to this FactoryTalk View ME object
Message Display	Multistate Indicator
Numeric Entry Cursor Point	Numeric Input Enable
Increment/Decrement Entry	Numeric Input Enable
ASCII Entry Cursor Point	String Input Enable
Numeric Display	Text object with numeric embedded variable
Connected Line	Polyline
Circle	Ellipse
Freeform	Freehand
Bar Graph and Gauge Inner Text	Bar Graph with separate Text object
Bar Graph and Gauge Inner Graphic	Bar Graph with separate Image object
Gauge Needle	Separate Gauge object. For example, in PanelBuilder32 software, a Gauge object is configured with two needles. This object is converted to two separate Gauge objects in Machine Edition software.

Reviewing Data Type Mapping

This table shows how data types map between PanelBuilder32 and Machine Edition software.

Table 11 - Data Type Mapping

PanelBuilder32 Data Types	Machine Edition Data Types
Bit	Digital
Bool	Digital
Char array	String (82 character max)
Unsigned integer	Unsigned
Signed integer	Int
IEEE	Floating Point (FP)
4BCD	4BCD
none	3BCD
none	Byte (unsigned 0...255)
Bit array	None
DINT	Long Int (signed 32 bit)
SINT (8 bit signed)	None

Reviewing Mapping of Communication Networks

This table shows communication protocols that are supported by PanelBuilder32 and FactoryTalk View ME applications.

Table 12 - Mapping of Communication Networks

PanelBuilder32 Communication Protocols	FactoryTalk View ME Communication Protocols
RS-232 (DF1)	RS-232 (DF1)
RS-232 (DH-485)	RS-232 (DH-485)
DH-485	DH-485
DH+™	DH+ Does not support nodes that use the AutoMax® node type
EtherNet/IP <ul style="list-style-type: none"> – EtherNet/IP controller address – EtherNet/IP CIP – Assembly object 	EtherNet/IP <ul style="list-style-type: none"> – Supported – Not supported – Not supported
RIO	RIO ⁽¹⁾
DeviceNet	Not supported ⁽¹⁾
ControlNet	ControlNet
	KEPWare communication drivers for third-party controllers

(1) Remote I/O and DeviceNet communication modules are not available for PanelView Plus 6 terminals.

Notes:

Review Unsupported Features

Introduction

In this chapter, you review unsupported features in FactoryTalk® View Machine Edition (ME) software. This review helps you resolve errors in the imported application.

Before You Begin

- Review migration considerations (Chapter 1).
- Select a PanelView™ Plus 7 terminal replacement and adapter kit, if necessary (Chapter 2).
- Optionally install the PanelView Plus 7 terminal in the existing PanelView Standard panel cutout (Chapter 2).
- Import your PanelBuilder32 .pba application into FactoryTalk View ME software (Chapter 3).
- Review the conversion log for your migrated application (Chapter 4).
- Review object mapping (Chapter 5).

What You Need

Conversion log generated by the FactoryTalk View ME import wizard for the imported application.

Follow These Steps

Follow this path to review unsupported features in FactoryTalk View ME software.

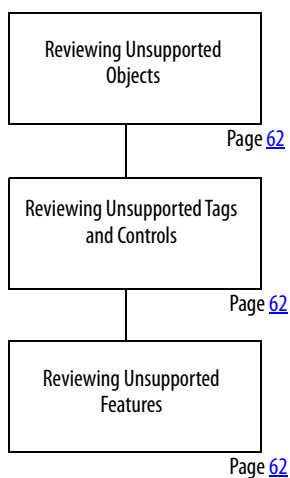

Reviewing Unsupported Objects

These PanelBuilder[®]32 objects are not supported in FactoryTalk View ME software:

- Print Only
- Circular Scale
- Scrolling Text
- Print Alarm Button
- Horn Silence Button and Lamp/Horn Test Button
- Select Operator Button
- Enable/Disable Security Button
- New Password Button
- Verify Password Button

Reviewing Unsupported Tags and Controls

These PanelBuilder32 controls are not supported in Factory Talk View ME software:

- Remote Ack All Handshake tag
- Remote Clear All Alarm tag
- Remote Clear All Alarm Handshake tag
- Message to Remote Device Notification tag
- Message to Remote Device Handshake tag
- Ack setting for alarms
- Bit alarm acknowledgement
- Handshaking for alarms that are sent to a remote device

Reviewing Unsupported Features

Some PanelBuilder32 features are not supported in FactoryTalk View Machine Edition software. Compare the conversion log with the information on unsupported features to assist with updates to your imported application. Additional information is provided where possible to achieve the same functionality by using another option or workaround in your imported application.

Table 13 - Unsupported Features in FactoryTalk View Machine Edition

Unsupported Feature	Object	Additional Information
Blink	Text Arc Ellipse Line Panel Rectangle Wedge	In FactoryTalk View ME software, all list objects use color animation to blink.
	Image	Color images do not blink. Monochrome images use the Blink property to enable blinking.
Allow Home/End Allow Wrap Ramping by Coarse Steps	Increment/Decrement Entry Button (Converted to Numeric Input Enable Button)	The Increment/Decrement Entry button is converted to a Numeric Input Enable button in FactoryTalk View ME software.

Table 13 - Unsupported Features in FactoryTalk View Machine Edition

Unsupported Feature	Object	Additional Information
Print Setting	Multistate Indicator Message Display	
Printing	Print Only Object	This object is not supported in FactoryTalk View ME software.
Initial State Values	Maintained Push button Multistate Push button Standard Control List Selector	To set the states of these objects on application startup, create a macro to set the appropriate tag values for the object controls. Assign the Macro in the Startup editor of FactoryTalk View ME software.
Least Significant Bit data format	Multistate Indicator Message Display List Indicator Standard Control List Selector	Bit triggered states are not supported in FactoryTalk View ME software. Modify the state values and the read tag, or assign an expression to return the value of the Least Significant Bit.
Inner Text and Inner Graphic	Bar Graph Gauge	In FactoryTalk View ME software, the Inner Text is converted to a separate Text object. The Inner Graphic is converted to a separate Image object.
Scale Clipping	Gauge	If the scale doesn't fit within the height or width of the gauge, it is not clipped. Check the position of the scale to make sure it doesn't overlap other objects.
Needle	Gauge	In FactoryTalk View ME software, each needle is converted to a separate Gauge object.
No Acknowledgement	Alarm List	In FactoryTalk View ME software, all alarms can be acknowledged.
Ack Setting	Alarm messages	In FactoryTalk View ME software, all alarms can be acknowledged.
Turn Object View On property	All objects	If this property is set to False, the converted object does not appear.
Embedded Variable	Numeric Display	Numeric Display objects are converted to Text objects with embedded variables.
Foreground and background colors	All objects	The foreground and background colors of PanelBuilder32 objects are used to set the Selection Fore and Selection Back color for FactoryTalk View ME objects. If the foreground and background colors are the same, the Selection Fore and Back colors are also the same. This color status means that the selected state is invisible, because the foreground color (text) and the background color are the same. To make the selected state visible, edit the object to change either the Selection Fore or Selection Back color.
Selected state visibility during design time and runtime	List Indicator Display List Selector Control List Selector Piloted Control List Selector Alarm List Selector	If the original Foreground Color (text) and Background Color of the object are the same, the selected state is invisible. To make the selected state visible, edit the object to change either the Selection Fore or Selection Back color.

Table 13 - Unsupported Features in FactoryTalk View Machine Edition

Unsupported Feature	Object	Additional Information
Caption and image placement	All objects	FactoryTalk View ME software supports one, three, or nine positions for captions and images, depending on the type of object. On conversion, captions and images are positioned using the closest match. Some captions might do the following: <ul style="list-style-type: none"> • Overlap images • Get truncated • Get clipped to fit the object Realign or resize objects for best fit.
Goto Configure Mode Button	Object not converted	
Security	Enable/Disable Security Button New Password Button Verify Password Button	In the PanelBuilder32 software, user passwords are create in the Configuration mode screens. FactoryTalk View ME software requires the Change Password button on a display.
	Security Settings	FactoryTalk View ME software uses a differnt method to assign security to graphic displays. You must reconfigure security. Once logged on, the operator does not need to reenter the password until manually logged off, or optionally after an idle time.

Qualify the Runtime Application

Introduction

In this chapter, you qualify the integrity of your converted application before downloading and running it in your production environment. Because you are using different software with new features and functionality, it is important to validate the application for proper operation.

Before You Begin

- Review migration considerations (Chapter 1).
- Select a PanelView™ Plus 7 terminal replacement and adapter kit, if necessary (Chapter 2).
- Optionally install the PanelView Plus 7 terminal in the existing PanelView Standard panel cutout (Chapter 2).
- Import your PanelBuilder32 .pba application into FactoryTalk® View ME software (Chapter 3).
- Review the conversion log for your migrated application (Chapter 4).
- Review object mapping (Chapter 5).
- Review unsupported features (Chapter 6).

What You Need

Converted FactoryTalk ME application.

Follow These Steps

Follow these steps to configure diagnostics, validate, test run, configure global memory connections, download, and run your converted application on a PanelView Plus 7 terminal.

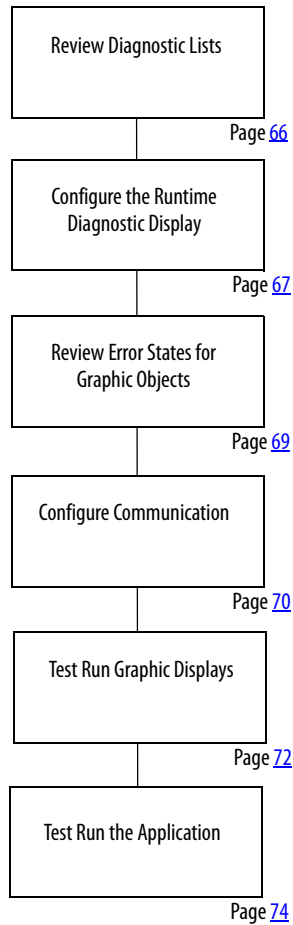

Review Diagnostic Lists

On your development computer, FactoryTalk View ME software features a diagnostic list at the bottom of the application window. You can configure FactoryTalk diagnostics to display information, warnings, and errors during application development and runtime.

When you test run your application, the diagnostic list displays messages and errors that are logged by the application. Use this list to identify the graphic objects or features that generated the messages or errors. Correct these errors during the validation process.

The diagnostic lists let you clear one or all messages in the list:

- Click the Clear button to delete the message that is displayed. If you resize the list to display multiple messages, select a message and then click Clear.
- Click the Clear All button to delete all messages in the list.



To view this diagnostic information during runtime, use either of the following:

- Default [DIAGNOSTICS] graphic display
- Diagnostic list object in a customized graphic display

TIP The [DIAGNOSTICS] display is in the Libraries editor of the application Explorer window if not already included in your application displays. Import the [DIAGNOSTIC] display if you are going to use it.

Configure the Runtime Diagnostic Display

Follows these steps to configure the default [DIAGNOSTICS] display to log errors or warnings that are generated during runtime operation.

1. Launch FactoryTalk View ME software if not open.
2. Open your converted application.
3. Expand the System folder in your application Explorer window.
4. Double-click Diagnostic List Setup.

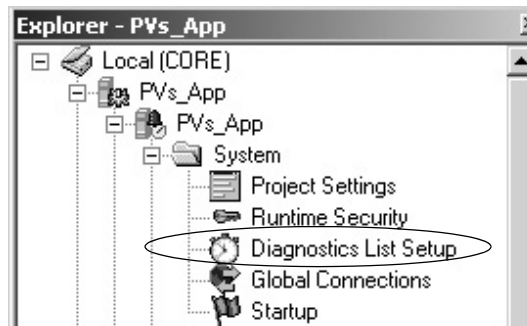

5. Under Runtime display, verify that [DIAGNOSTICS] is the Display name.

This display is the default diagnostic display that pops up during runtime when configured events occur.

6. Check the boxes next to the messages that you want to appear in the display when events occur during runtime.

It is recommended that you always log errors and warnings during runtime.

For information on how each dialog option is designed to function during runtime, click Help.

7. Click OK.



Review Error States for Graphic Objects

In FactoryTalk View ME software, error conditions for visible objects may be different than the error conditions in PanelBuilder®32 software. The table clarifies what happens when errors occur for objects when tags are unavailable or communication is lost.

For additional information on objects, refer to the FactoryTalk View Machine Edition online help.

Table 14 - Error Modes for Objects

Graphic Object	Visible Error Mode
<ul style="list-style-type: none"> • Momentary Push Button • Maintained Push Button • Latched Push Button • Multistate Push Button 	The caption displays 'default error message' for the error state.
<ul style="list-style-type: none"> • Interlock Push Button • Ramp Push Button 	No visible error message or error condition is displayed. When you click these objects, an error message is generated and logged to the diagnostic list object.
<ul style="list-style-type: none"> • Numeric Display • Numeric Input Cursor 	These objects display asterisks, *****.
<ul style="list-style-type: none"> • Numeric Input Enable • String Input Enable • String Display 	No visible error message or error condition is displayed. When you click these objects, an error message is generated and logged to the diagnostic list object.
<ul style="list-style-type: none"> • Goto Display Button • Return To Display Button • Display List Selector • Close Display Button 	No visible error message or error condition is displayed. If communication to the PLC controller is lost, these buttons still let you navigate through your application.
Multistate Indicator	The caption displays Error for the error state.
Symbol Properties	The object shows the image color that is defined in the error state.
List Indicator	No visible error message or error condition is displayed.
Bar Graph Gauge	This object shows a transparent wireframe box.
Scale	No visible error message or error condition is displayed.
Local Message Display	This object displays question marks, ??????, in the error state.
<ul style="list-style-type: none"> • Backspace • End • Enter • Home • Move Left • Move Right • Move Down • Page Up • Page Down 	No visible error message or error condition is displayed.
<ul style="list-style-type: none"> • Sort Alarm • Reset Alarm • Alarm Banner • Alarm Status List 	No visible error message or error condition is displayed.
Display Print	No visible error message or error condition is displayed.
Trend	This object appears not to have any pens and does not perform real time trending.
Time and Date	No visible error message or error condition is displayed.

Configure Communication

You are now ready to configure communication for your imported application. Because this application is a new application, a communication configuration does not exist. The configuration varies depending on the communication protocol you use.

Follow these steps to configure communication for your application.

1. In the Explorer window, expand RSLinx® Enterprise and double-click Communication Setup.

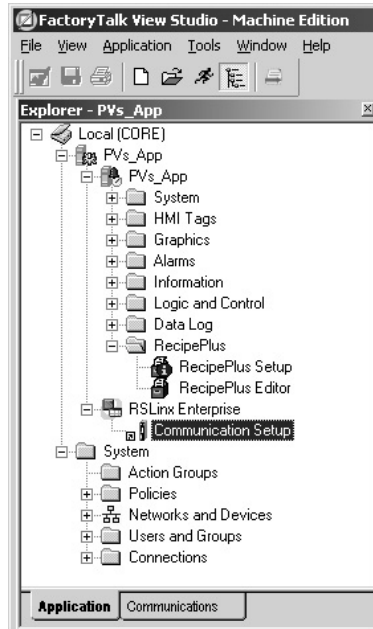

2. Select Create a New Configuration and click Finish.

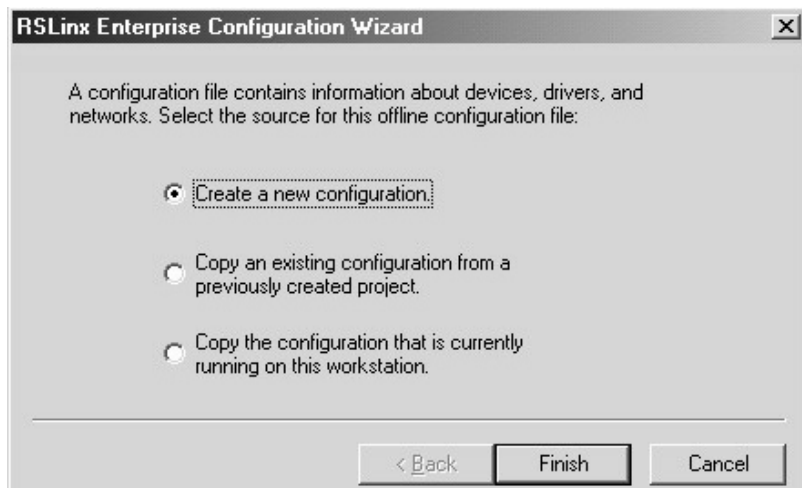

3. In the Communication Setup dialog box, select the Local tab.

This communication path is used for testing individual displays and Test Application.

4. Select the driver that you are using in your design environment to test communication.

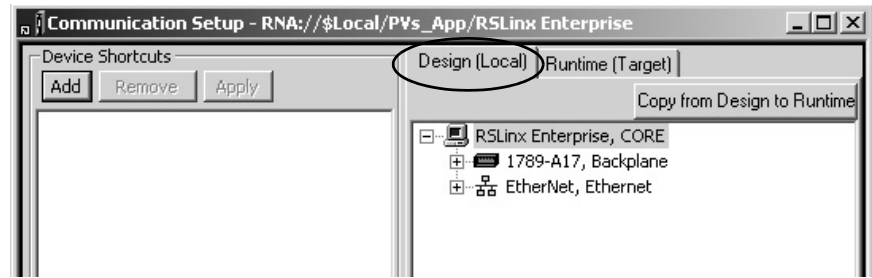

Browse to the controller device and configure local communication.

5. Select the Target tab.

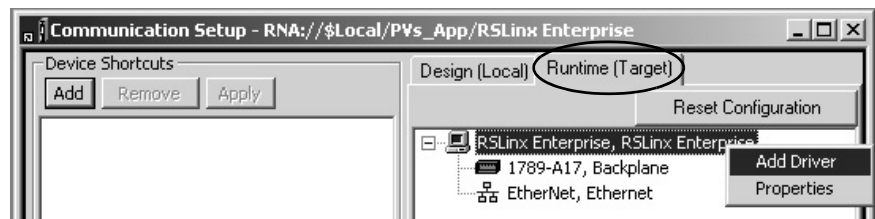

This communication path is used on the PanelView Plus to communicate to the controller in your runtime application in Chapter 8.

6. Right-click RSLinx Enterprise and select Add Driver.
7. Select the appropriate driver and click OK.

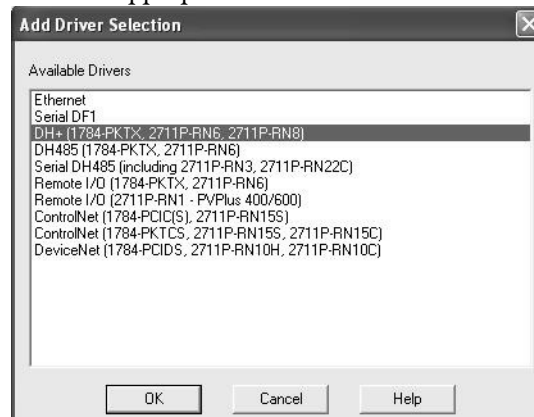

8. Configure the driver properties.

TIP Remote I/O and DeviceNet communication modules are not supported by the PanelView Plus 7 terminals.

PanelView Plus Compact 400, 600, and 1000 terminals are fixed hardware configurations that do not support communication modules.

For	On This Terminal	+	Communication Module	Select
DH+™	PanelView Plus 6 (700...1500) ⁽¹⁾	+	2711P-RN6 or 2711P-RN6K	DH+ (1784-PKTX, 2711P-RN6, 2711P-RN8)
	PanelView Plus 400 or 600	+	2711P-RN8	DH+ (1784-PKTX, 2711P-RN6, 2711P-RN8)
DH-485	PanelView Plus 6 (700...1500) ⁽¹⁾	+	2711P-RN6 or 2711P-RN6K	DH-485 (1784-PKTX, 2711P-RN6)
	PanelView Plus 400 or 600	+	2711P-RN3	Serial DH-485 (including 2711P-RN3, 2711P-RN22C)
ControlNet	PanelView Plus 6 (700...1500) ⁽¹⁾	+	2711P-RN15S or 2711P-RN15SK	ControlNet (1784-PCIC, 1784-PCICS, 2711P-RN15S) or ControlNet (1784-PKTCS, 2711P-RN15S, 2711P-RN15C)
	PanelView Plus 400 or 600	+	2711P-RN15C	ControlNet (1784-PKTCS, 2711P-RN15S, 2711P-RN15C)

(1) Also applies to PanelView Plus 700 to 1500 terminals running FactoryTalk View Machine Edition Firmware Revision 5.1 or earlier.

ControlNet Communication

See ControlNet Communication for PanelView Plus 7 Terminals user manual, publication, [2711P-UM003](#), for step-by-step details on how to configure ControlNet Scheduled and Unscheduled communication with FactoryTalk View ME software.

Test Run Graphic Displays

FactoryTalk View ME software provides a Test Display mode to test the animation and assigned tags that are connected to objects in a graphic display. Any information, warning, or errors are logged to the diagnostic list for your review.

Test Display mode tests all objects in a display:

- Button objects
- Numeric and string objects to verify that correct values are displayed
- Objects that require user input
- Objects that use animation

IMPORTANT You must be connected to the controller and online before test running the display or all objects show their error states.

For each object tested, review and correct any errors and warnings that are logged to the diagnostic list. Retest the display object before proceeding to the next object.

IMPORTANT In Test Display mode, objects in the display are activated and connected to assigned tags. Only tags connected to objects in the display work. Links to other displays or alarms, including data logging, macros, global connections, and information messages do not work.

Follow these steps to activate Test Display mode for a display and then return to Edit mode. Running Test Display mode and correcting logged errors in Edit mode is an iterative process.

1. Open the display that you want to test.
2. Access Test Display mode in one of two ways.
 - Choose Test Display from the View menu.

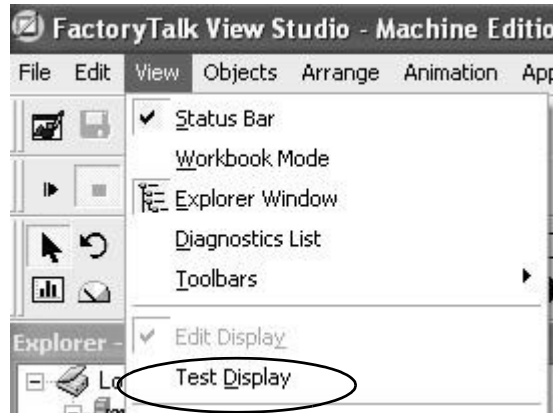

- Click the Test Display button on the toolbar.



3. Return to Edit mode in one of two ways.
 - Choose Edit Display from the View menu.

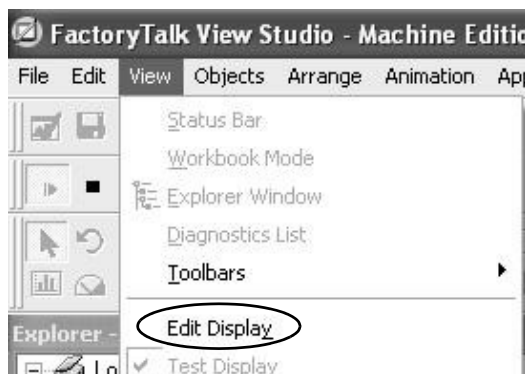

- Click the Edit Display button on the toolbar.

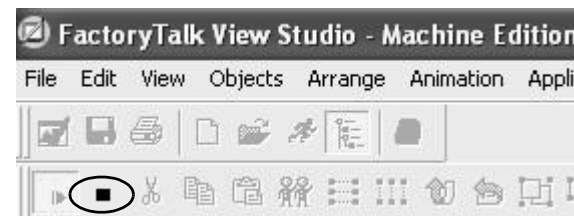

Test Run the Application

After testing and verifying that each graphic display is error free, you are ready to test run the entire application. Application Test mode lets you navigate through the entire application to validate functions that are not tested in Display Test mode. Some of these features include alarming, data logging, information messages, global connections, and macros.

As you navigate through displays in Application Test mode, the Diagnostic List logs warnings and errors as they occur. Correct all logged errors and then retest the application to validate error correction.

IMPORTANT You must be connected to the controller and online before testing the application for accuracy.

Follow these steps to test run an application.

1. Open your converted application in FactoryTalk View ME software.
2. Test the application in one of two ways.
 - Choose Test Application from the Application menu.

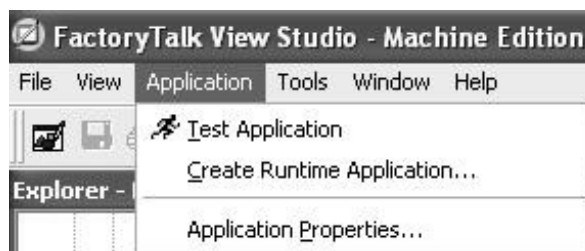

- Click the Test Application icon on the toolbar.



The emulator opens on your computer and runs the application. There is a two-hour limit for using the runtime emulator.

TIP Local messages and graphic objects that are configured for multiple languages display in the current language of the application while in Test Application mode.

3. To exit the emulator, press x on your keyboard.

TIP The emulator window requires focus when pressing the x key to exit the emulator.

Create the Runtime Application

Introduction

In this chapter, you create, download, and run the converted application with all modifications on the PanelView™ Plus 7 terminal.

Before You Begin

- Review migration considerations (Chapter 1).
- Select a PanelView Plus 7 terminal replacement and adapter kit, if necessary (Chapter 2).
- Optionally install the PanelView Plus 7 terminal in the existing PanelView Standard panel cutout (Chapter 2).
- Import your PanelBuilder32 .pba application into FactoryTalk® View ME software (Chapter 3).
- Review the conversion log for your migrated application (Chapter 4).
- Review object mapping (Chapter 5).
- Review unsupported features (Chapter 6).
- Qualify the runtime application (Chapter 7).

What You Need

- Converted FactoryTalk View ME application.
- Qualified runtime application.

Follow These Steps

Follow these steps to create a runtime application, download, and run the application on the PanelView Plus 7 terminal.

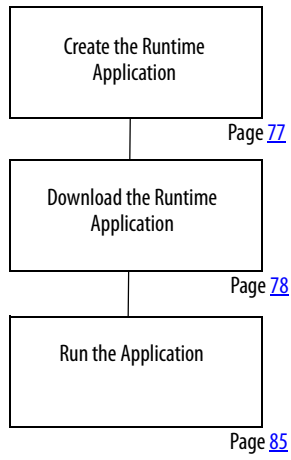

Create the Runtime Application

Follow these steps to create a runtime application file from your converted Machine Edition .mer file.

1. Open your converted application in FactoryTalk View ME software.
2. Choose Create Runtime Application from the Application menu.

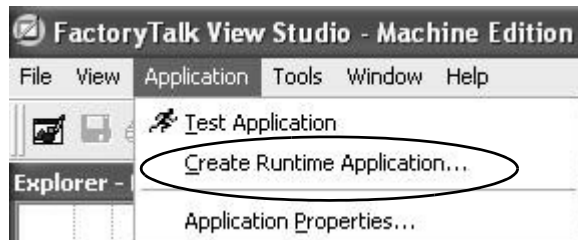

3. Enter a name for your runtime application or accept the default name.
4. Click Save to create the runtime file.

The file is saved to the default runtime location.

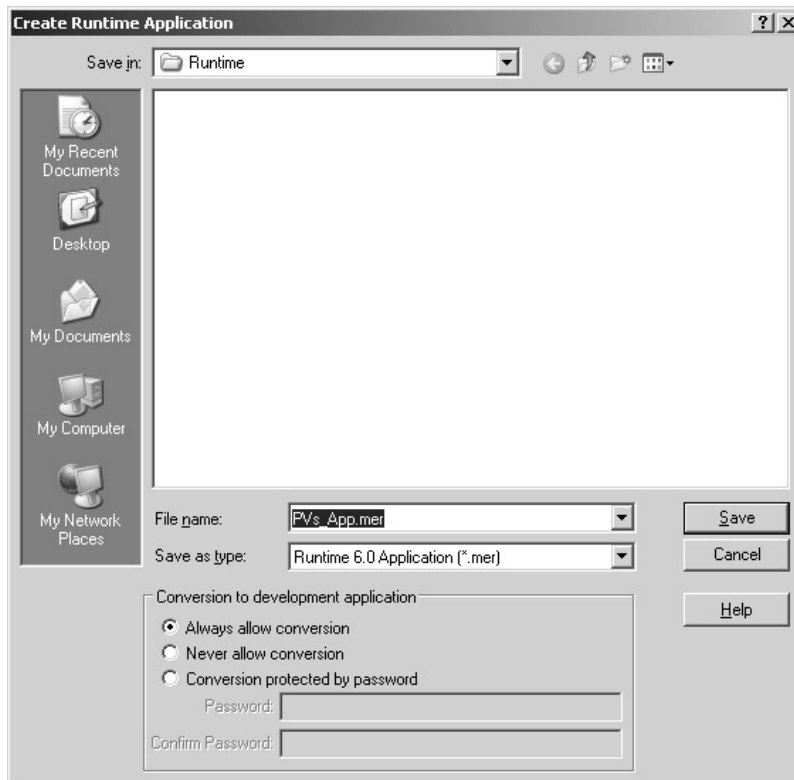

A dialog box shows the status of the runtime file creation. When the process completes, the dialog box automatically closes.

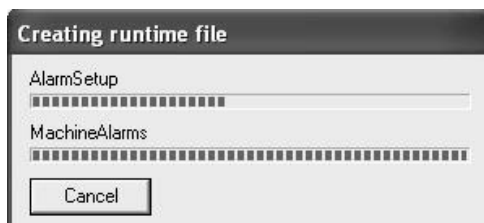

Download the Runtime Application

You can download your runtime .mer application to a PanelView Plus 7 terminal by using an Ethernet connection or external storage device that is supported by your terminal.

Download Application Using Ethernet Connection

Follow these steps to download your runtime application to the PanelView Plus 7 terminal by using an Ethernet connection.

1. Establish an Ethernet connection between your computer and the terminal.
2. Launch the transfer utility in one of two ways.
 - a. Choose Transfer Utility from the Tools menu.

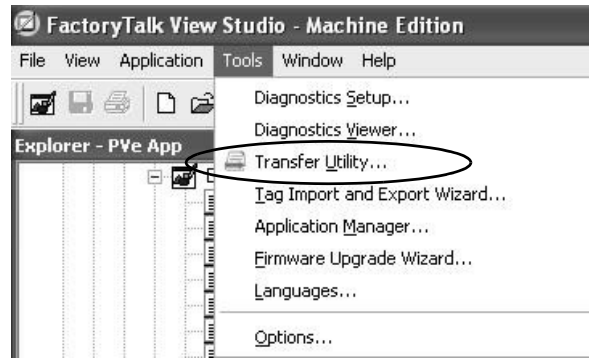

- b. Click the appropriate tool on the toolbar.



3. To browse for the runtime file that you just created, click the ... button.

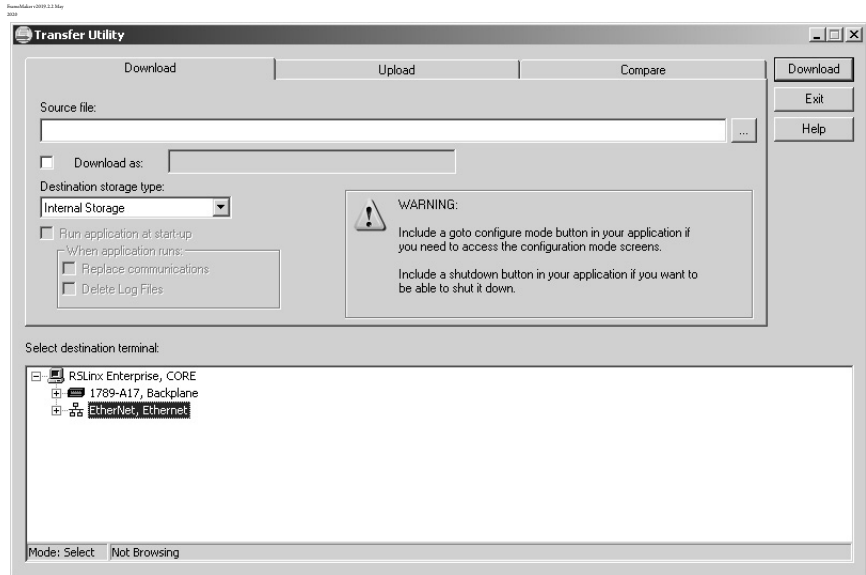

4. Select the runtime file that you just created and click Open.

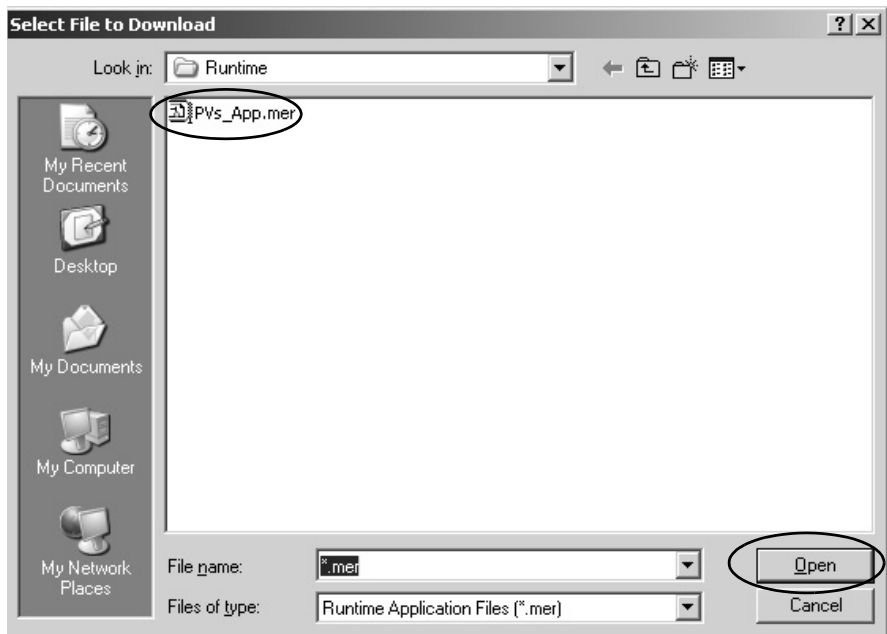

5. Under Select destination terminal, expand the Ethernet driver.
6. Browse for and select your PanelView Plus 7 terminal.

7. Click Download to download the runtime file to the PanelView Plus 7 terminal.

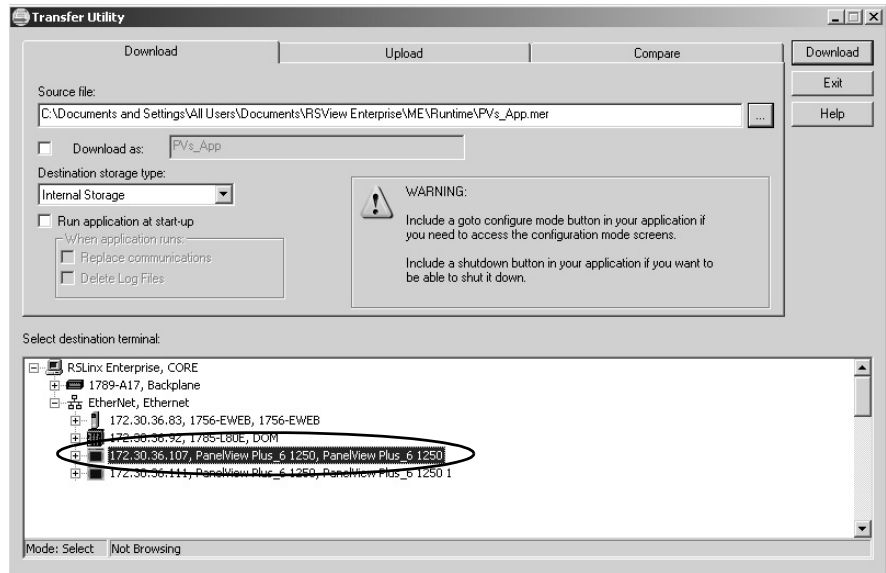

A progress bar shows the status of the download.

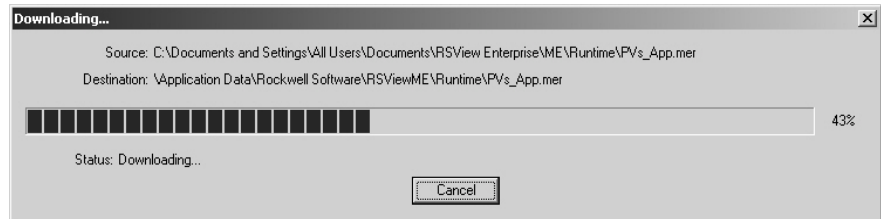

8. Click OK when the download has completed successfully.

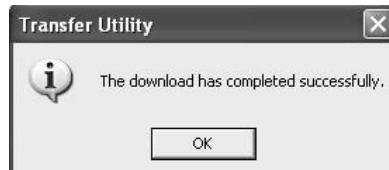

9. On the PanelView Plus 7 terminal, load the application by pressing the Load Application button or pressing the [F1] function key.

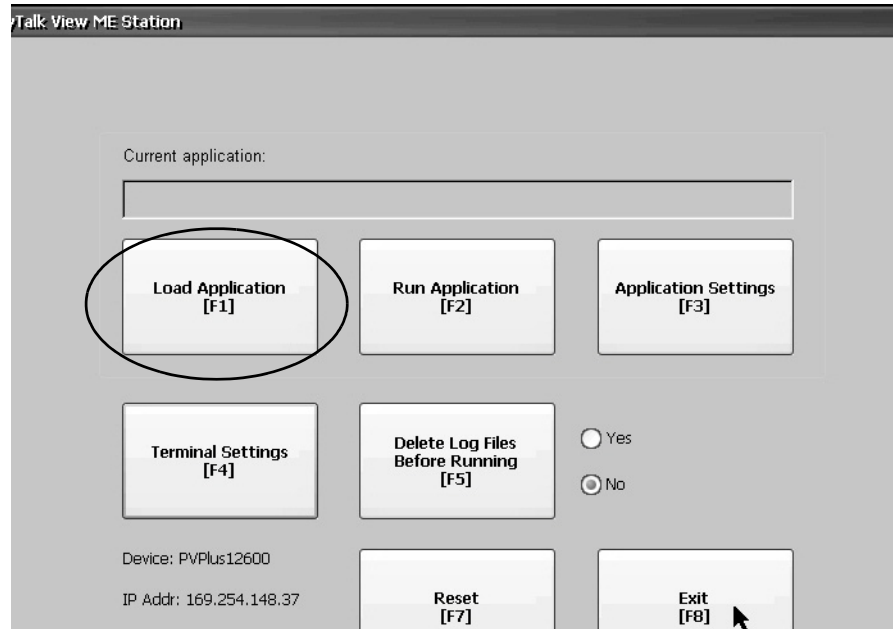

10. Select your runtime application.
- Press the up or down cursor to select the application if multiple applications exist.
 - Press the Load button or the [F2] function key on terminal.

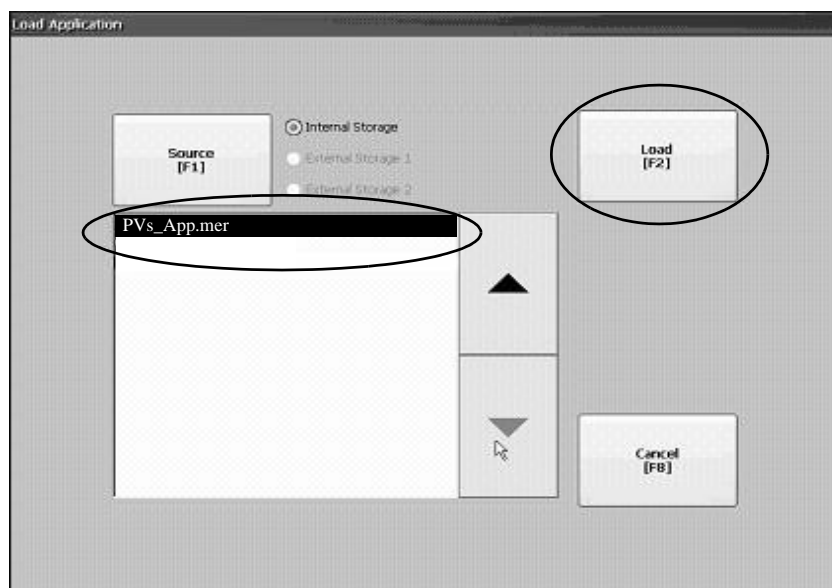

11. Press Yes or the [F7] function key on terminal to replace the communication settings in the terminal with the settings in your runtime application.

You are now ready to run the application on the terminal. Skip to page [85](#).

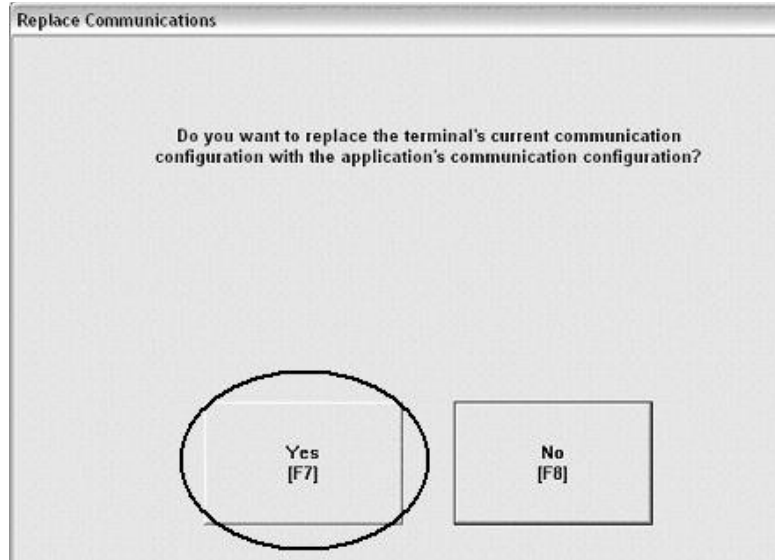

Download Application Using External Storage

Follow these steps to load the runtime application on the PanelView Plus 7 terminal by using an external storage card.

Table 15 - External Storage Media

This Terminal Platform	Supports This External Storage
PanelView Plus 7	Secure Digital (SD) card, cat. no. 1784-SDx
	USB flash drive on USB host ports

1. On your computer, copy the runtime application file to the runtime folder on a storage card that is supported by the terminal.

IMPORTANT The root of the CompactFlash card must have the path 'RockwellSoftware\RSViewME\Runtime' or the application file is not recognized at runtime.

2. Turn off power to the terminal.

3. Load the storage card into the card slot of the terminal.

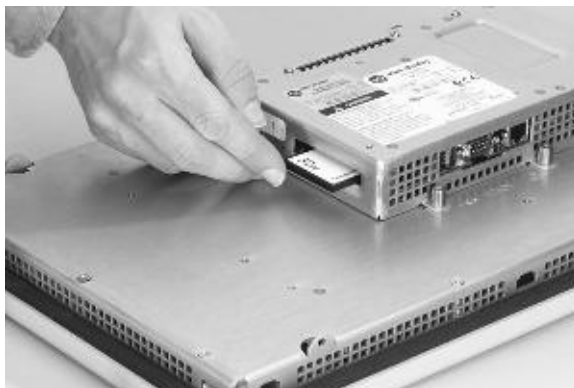

CompactFlash Card Slot on PanelView Plus 700 and 1500 terminals that support FactoryTalk View Machine Edition software version 5.1 or earlier.

SD Card Slot and USB Host Port on PanelView Plus 6 Terminals

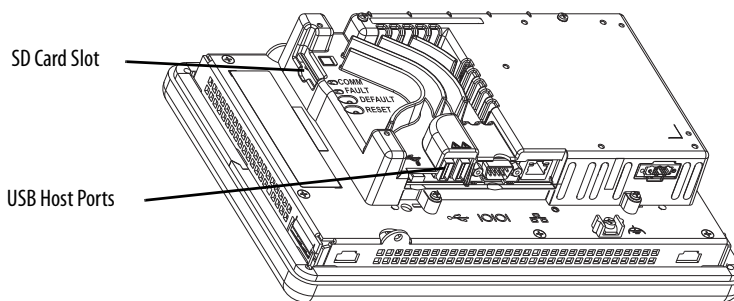

4. Turn on power to the PanelView Plus 7 terminal.
5. On the configuration display, press Load Application or the [F1] function key on the terminal.

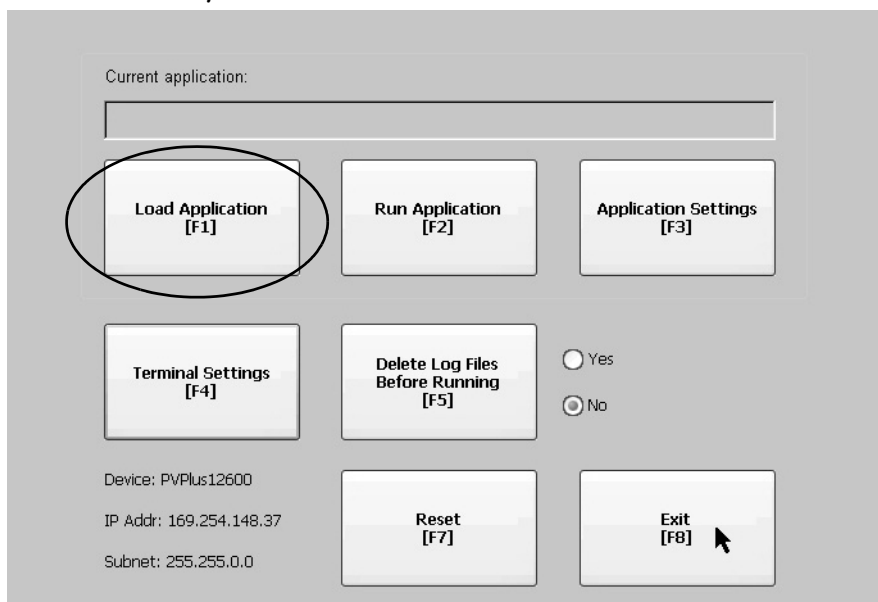

6. To select External Storage 1 or 2, press the Source button or [F1] on the terminal.
7. Select your runtime application.
 - c. To select the application (if multiple applications exist), press the up or down cursor.
 - d. Press the Load button or [F2] function key on the terminal.

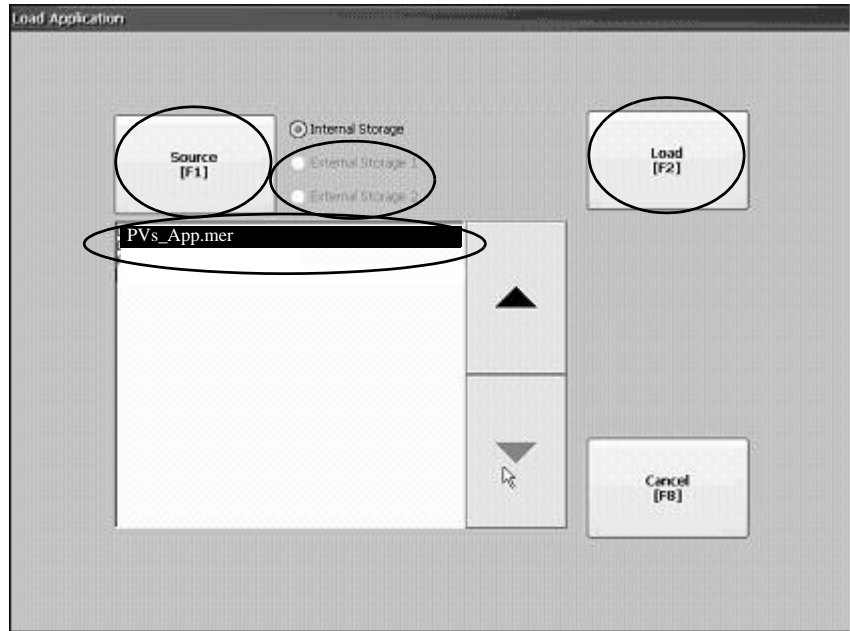

8. To replace the communication settings in the terminal with the settings in your runtime application, press Yes or the [F7] function key on the terminal.

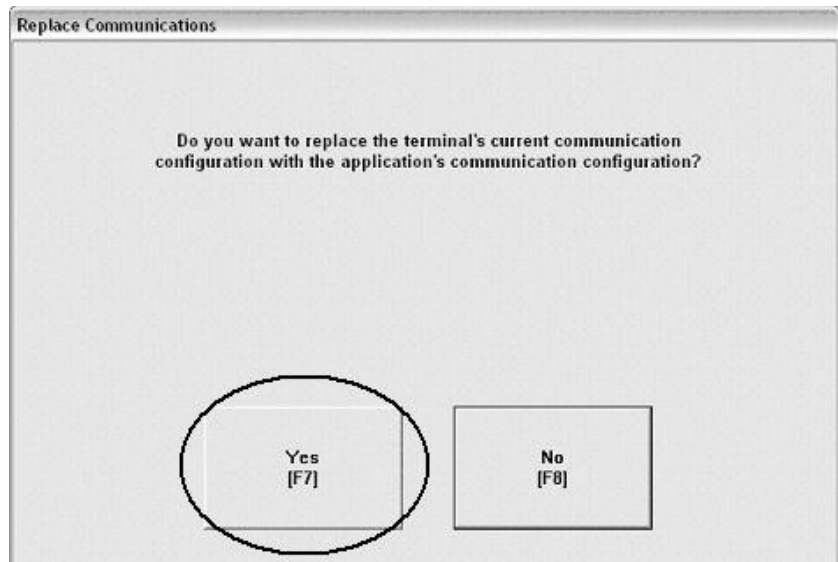

Run the Application

Follow these steps to run your application on a PanelView Plus 7 terminal.

1. To run the currently loaded application, press Run Application or the [F2] function key on the terminal.

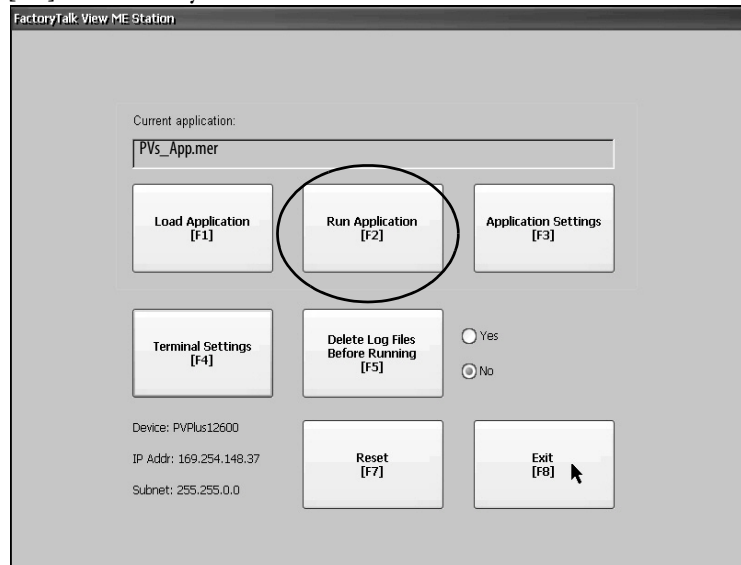

-
- IMPORTANT** If your application is not communicating to the controller:
- Check all cable connections.
 - Verify that the Target tab in the RSLinx® Enterprise Communication Setup is configured correctly.
-

2. Cycle through all runtime displays continuously.

Notes:

Optimize Runtime Performance

Introduction

In this chapter, you learn how to benchmark performance of your runtime application so that you can optimize as needed.

Before You Begin

- Review migration considerations (Chapter 1).
- Select a PanelView™ Plus 7 terminal replacement and adapter kit, if necessary (Chapter 2).
- Optionally install the PanelView Plus 7 terminal in the existing PanelView Standard panel cutout (Chapter 2).
- Import your PanelBuilder32 .pba application into FactoryTalk® View ME software (Chapter 3).
- Review the conversion log for your migrated application (Chapter 4).
- Review object mapping (Chapter 5).
- Review unsupported features and common migration issues (Chapter 6).
- Correct, validate, and test the application (Chapter 7).
- Create, download, and run the application on a PanelView Plus 7 terminal (Chapter 8).

What You Need

- A converted FactoryTalk View ME runtime application file that is downloaded and loaded in your PanelView Plus terminal.

Follow These Steps

Follow this path to benchmark and optimize the performance of your converted application.

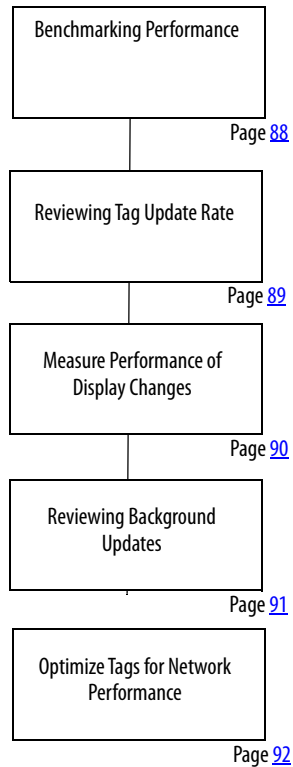

Benchmarking Performance

You are now ready to compare performance of your PanelBuilder®32 application running on a PanelView Standard terminal and the converted FactoryTalk View ME application running on a PanelView Plus 7 terminal.

You perform the benchmarking by functional areas so that you can optimize performance one step at a time. Each function may also provide alternative methods to improve performance where needed.

IMPORTANT Performance benchmarking between the terminal platforms is critical so that operators experience the same, if not better, performance on the new platform.

Reviewing Tag Update Rate

The tag update response is dependent on where the tag is used in the application. Each display or feature has a maximum tag update rate. This parameter specifies the maximum rate at which new data is updated on the display, including tags used in expressions and embedded variables.

The default tag update rate is 1.0 second.

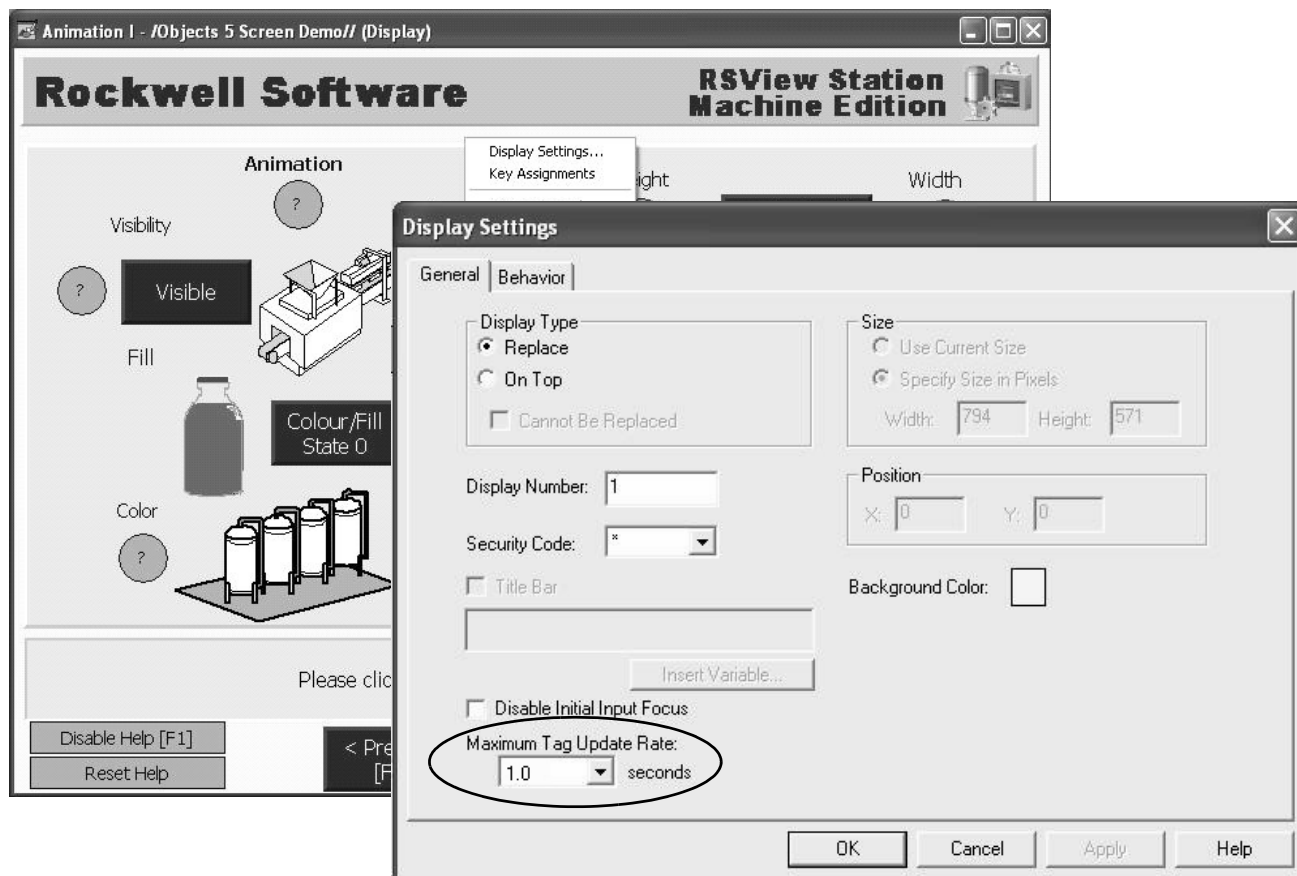

Measure Performance of Display Changes

During performance benchmarking, you may want to measure the time it takes for the application to change from one display to another. It is important that the operator experiences the same display feedback, if not better, on the PanelView Plus 7 terminal.

If possible, place your PanelView Standard terminal and the new PanelView Plus 7 terminal side by side. Run the original PanelView Standard application and the converted PanelView Plus 7 application simultaneously.

Follow these steps to measure the length of time it takes to change from one display to another in the application.

1. Load and run your converted application on the PanelView Plus 7 terminal.
2. To record the time it takes to change from one display to another display, use a stopwatch in the next steps.
3. On any display, press the button that results in a display change and start recording the time.
4. Stop recording the time after all tag information is loaded on the next display.
5. Repeat steps 3 and 4 until you have recorded the times for all displays in the application.

IMPORTANT Cycle through all displays at least twice. The first time that you open a display it loads slower than subsequent displays because tag information is cached into memory after a display is opened.

6. If possible, repeat this procedure for the same application on the PanelView Standard terminal.

In a FactoryTalk View ME application, each display can have a maximum of 1000 tag connections assigned. The more tag connections a display has, the longer it takes to load the display.

If performance is slower for some displays in the PanelView Plus 7 application, you can do one of the following:

- Adjust the maximum tag update rate for these displays
- Reduce the number of tags that are used on these displays

Reviewing Background Updates

Background tags are continuously updated by the runtime application whether or not the operator is on a specific display. Tags update according to the maximum tag update rate for the associated feature.

The more familiar you are with these tags and features, the easier it is to update and fine tune your application.

TIP Set noncritical tags to a longer maximum update rate. Set critical tags to a lower rate so that time-sensitive information is always available to the operator.

Global Connections

The Global Connections editor provides a list of connections that you can assign to tags:

- Date and Time
- Display
- Macro
- Backlight
- Memory

These tags are continuously updated in the background by the application, regardless of what display is active. The tags update according to the setting of the maximum update rate parameter.

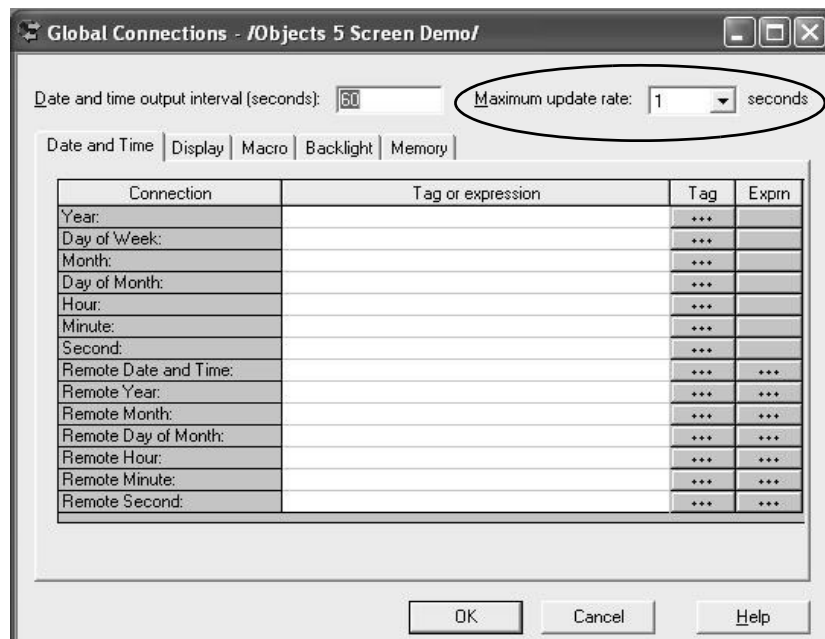

Alarms

The Alarm Setup editor lets you define triggers, messages, and advanced features for alarms. Any trigger tags or optional connections that are assigned within the editor update according to the maximum update rate. This parameter is on the Advanced tab.

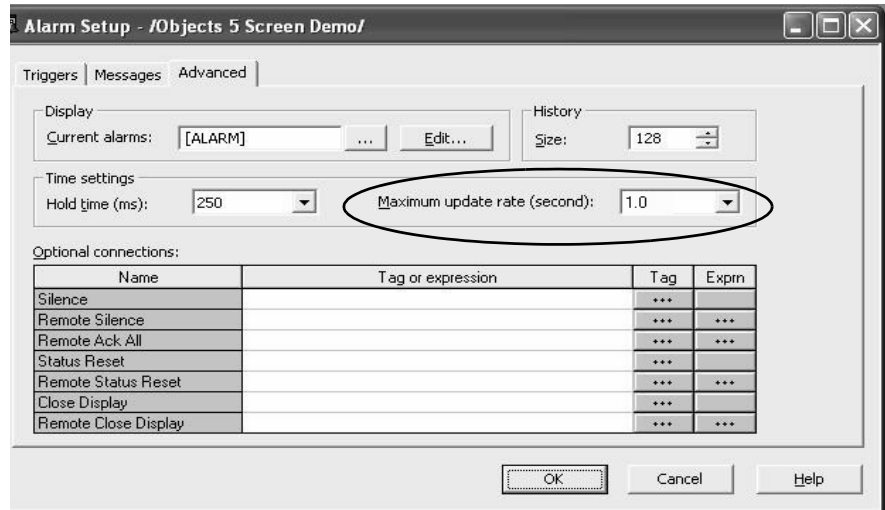

Information Messages

The Information Message editor lets you specify information messages to automatically display on a user-defined display. The tags that are assigned in this editor, update at the rate defined by the maximum update rate.

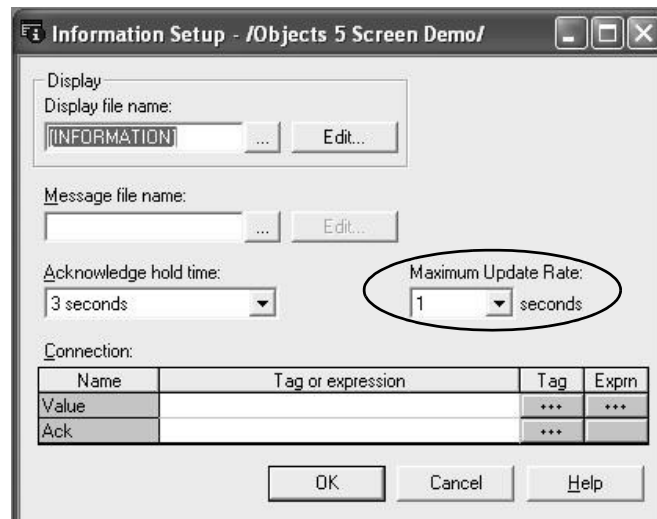

Optimize Tags for Network Performance

You can further improve network performance by converting the application tags from HMI tags to direct reference tags.

The tag converter wizard (TCW) automatically converts tags in an application from HMI tags to direct reference tags.

TIP You can download The TCW utility from the Knowledgebase. See Technote 31289.

About the Tag Converter Wizard

The tag converter wizard (TCW) requires information from an existing application to perform the conversion:

- Exported HMI tag database
- Exported displays (xml format)
- Exported alarms (xml format)

When this pre-conversion information is available, you can run the wizard. The wizard examines the HMI tag database to determine which tags to convert to alias tags or direct reference tags.

IMPORTANT The tag converter wizard converts HMI tags to device tags. It does not convert device tags to HMI tags. Back up your application before starting the conversion. The conversion alters the original displays when imported into your new application.

Remote I/O Applications

IMPORTANT For Remote I/O applications, HMI tags that use custom scale and offsets are not converted. Any alias tags with initial values assigned are not converted. You must manually set the custom scale, offsets, and initial values for these tags, for objects to operate correctly.

The HMI tags are substituted with the alias or device tags in the display and alarm xml files. When the conversion is done, a Convert_Log.txt file is generated. This file indicates all tag substitutions on a display-by-display basis. A new set of display and alarm xml files are created that you can import into your migrated application. The original display and alarm xml files are unaltered.

Non-Remote I/O Applications

For all non-Remote I/O applications, HMI tags are converted to direct reference tags regardless of scale, offset, and min/max values. This conversion includes Ethernet, DF1, DH+™, and DH-485 applications.

IMPORTANT Memory tags are not converted. You must convert memory tags manually before running the Tag Converter Wizard.

The TCW does not add the L parameter to alarm trigger tags. See [page 8](#) for details on converting alarm trigger tags to direct reference.

Export the HMI Tag Database

Follow these pre-conversion steps to export the HMI tag database in your migrated application.

1. Launch FactoryTalk View Studio software.

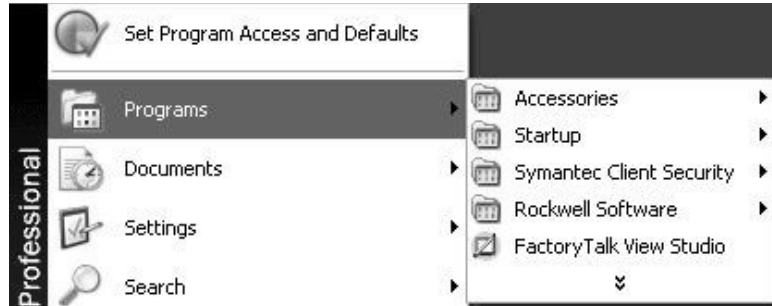

2. Select your ME application and click Open.

This example selects `Baggage_800x600`.

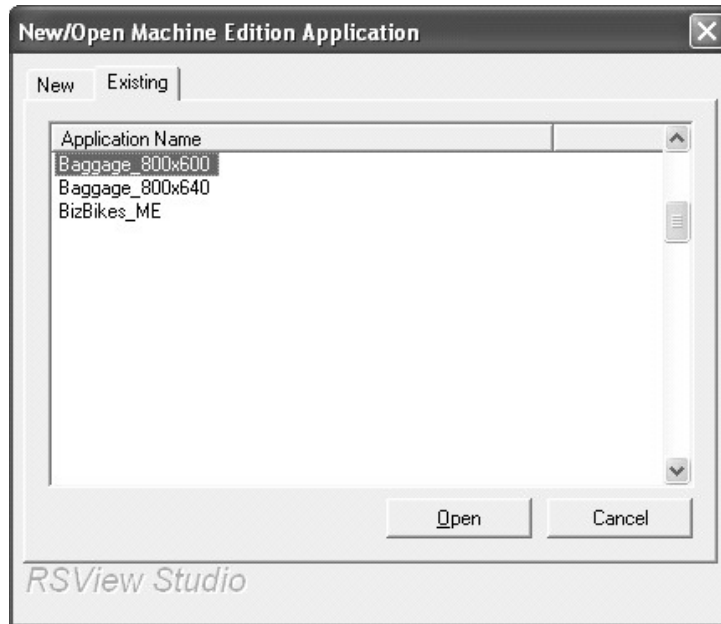

- Choose Tools>Tag Import and Export Wizard from the Tools menu.

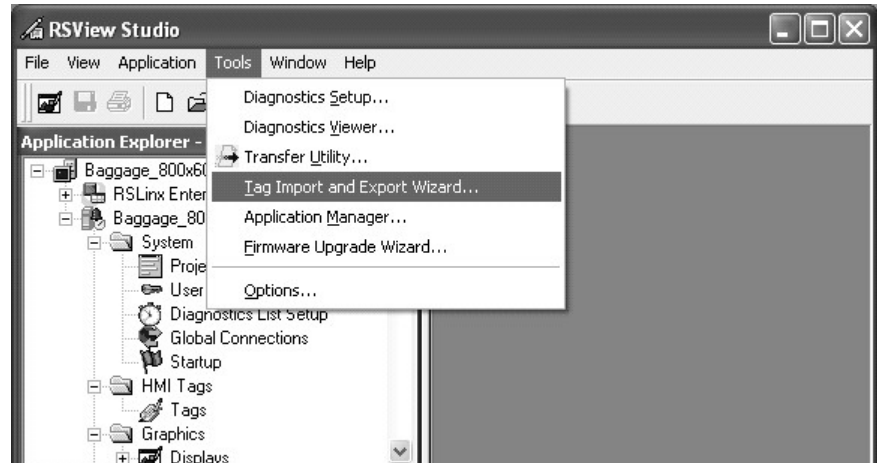

- In the Operation field, select Export FactoryTalk View tag database to CSV files and click Next.

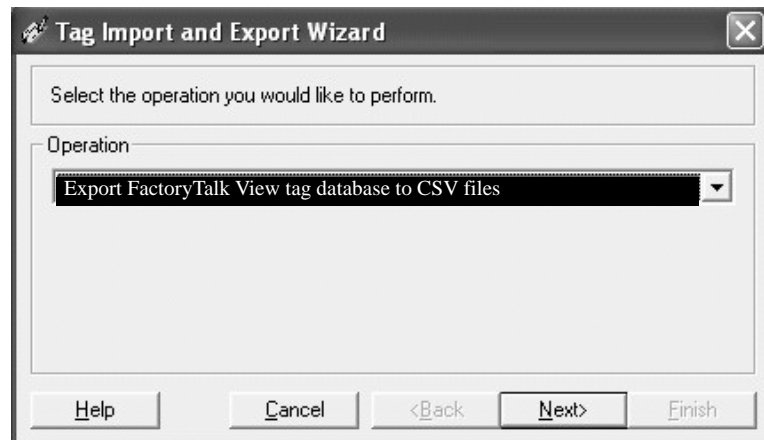

- Click the ... button and browse to the project .med file and click Next.

This example uses Baggage_800x600.med.

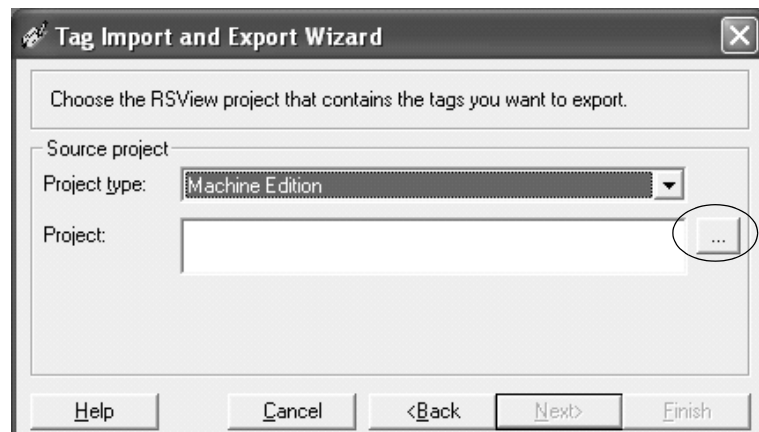

- Accept the default name for the destination file.

7. Click Finish.

You have successfully exported the HMI tag database.

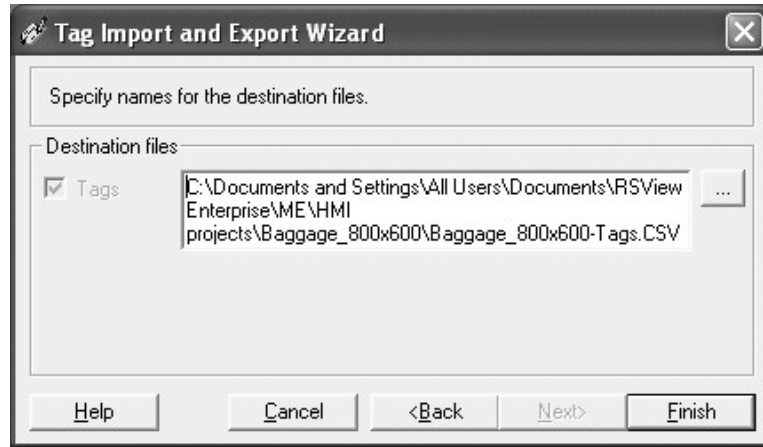

The default destination of the .csv file is:

C:\Documents and Settings\All Users\Documents\RSView
Enterprise\ME\HMI Projects\Project_Name\Project_Name-Tags.CSV

Export Graphic Displays to XML File

Follow these pre-conversion steps to export the graphics display in your converted application to an xml format.

1. Navigate back to the open instance of the FactoryTalk View Studio software.
2. In the Application Explorer, right-click Displays and choose Import and Export.

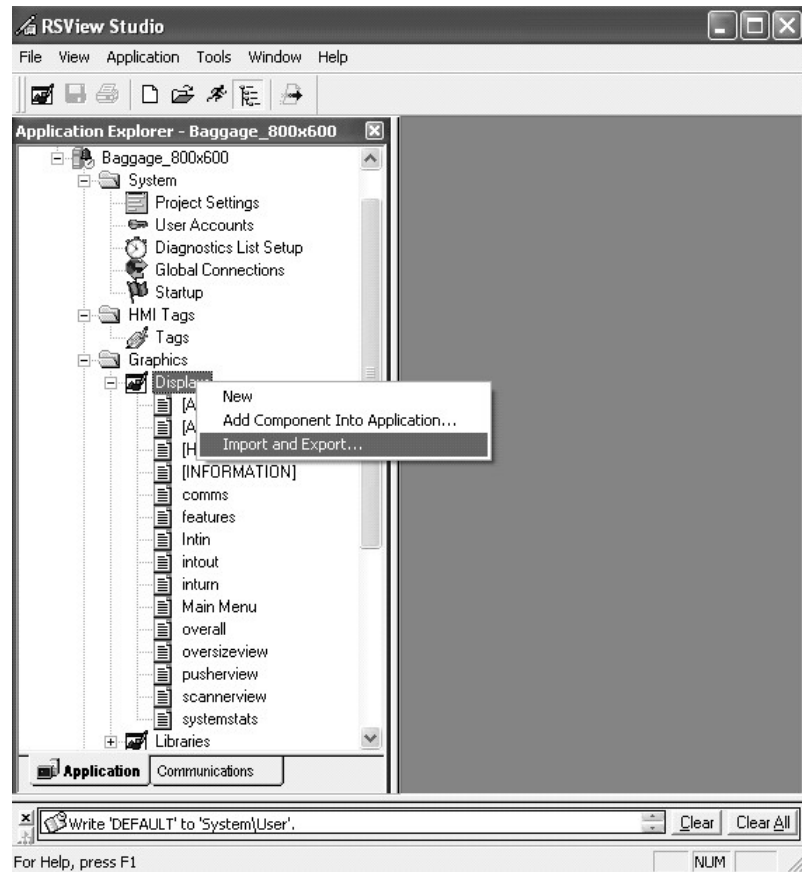

3. Select Export graphic information from displays and click Next.

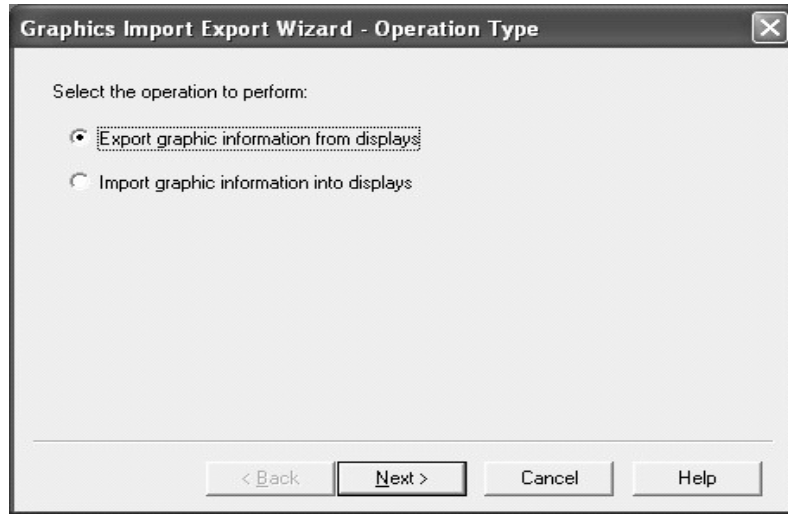

4. Click Select All, then Next.

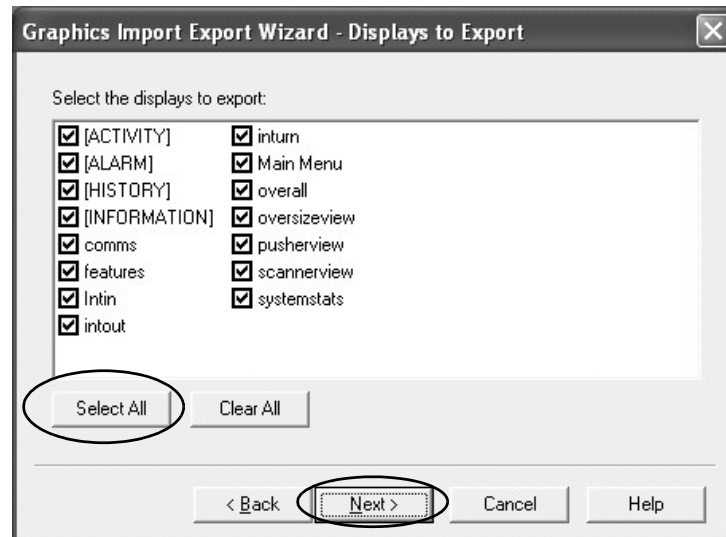

5. Click the ... button.
6. Create a folder anywhere on your computer named Exported Displays.

7. Click Finish.

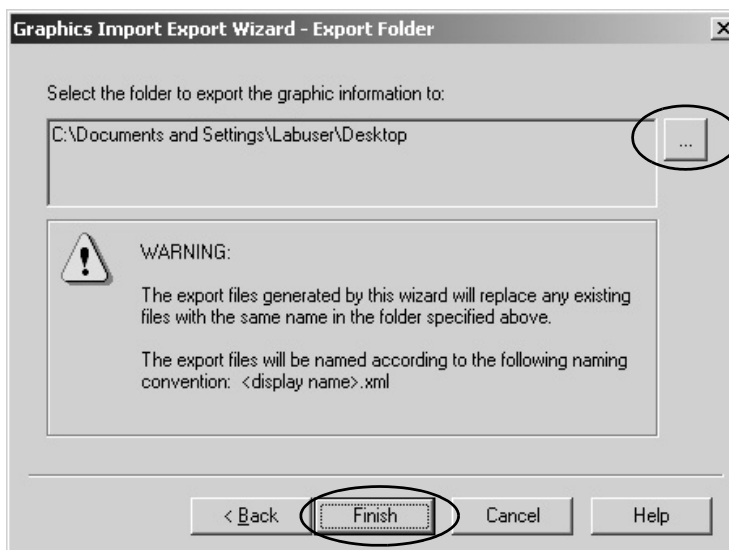

A dialog box shows the name of each graphic display as it is exported to an .xml file.

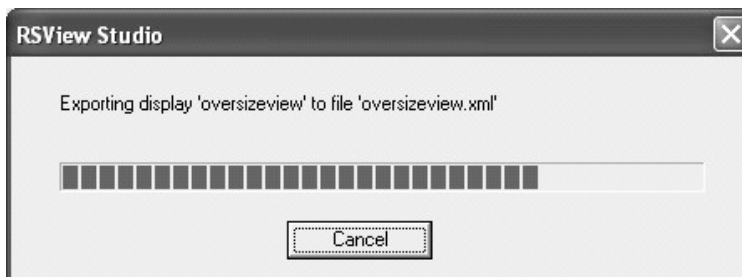

8. Review the Display_Export.txt file for any errors that are generated during the export.

The displays have been successfully exported to the folder created in step 6.

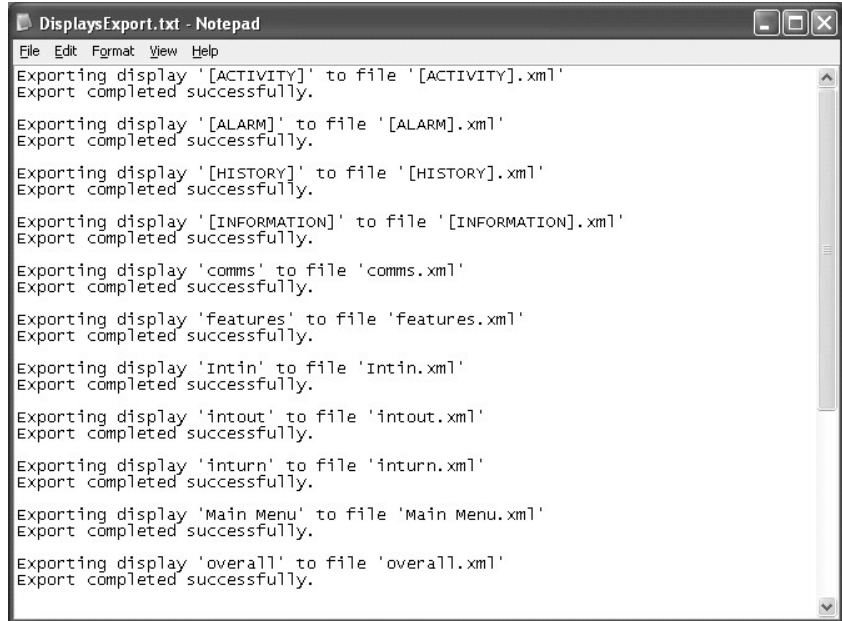

```
DisplaysExport.txt - Notepad
File Edit Format View Help
Exporting display '[ACTIVITY]' to file '[ACTIVITY].xml'
Export completed successfully.
Exporting display '[ALARM]' to file '[ALARM].xml'
Export completed successfully.
Exporting display '[HISTORY]' to file '[HISTORY].xml'
Export completed successfully.
Exporting display '[INFORMATION]' to file '[INFORMATION].xml'
Export completed successfully.
Exporting display 'comms' to file 'comms.xml'
Export completed successfully.
Exporting display 'features' to file 'features.xml'
Export completed successfully.
Exporting display 'Intin' to file 'Intin.xml'
Export completed successfully.
Exporting display 'Intout' to file 'Intout.xml'
Export completed successfully.
Exporting display 'Inturn' to file 'Inturn.xml'
Export completed successfully.
Exporting display 'Main Menu' to file 'Main Menu.xml'
Export completed successfully.
Exporting display 'overall' to file 'overall.xml'
Export completed successfully.
```

Export Alarms to XML File

Follow these pre-conversion steps to export alarms in your converted application to an xml format.

1. Navigate back to the open instance of the FactoryTalk View Studio software.
2. In the Application Explorer, right-click Alarm Setup and choose Import and Export.

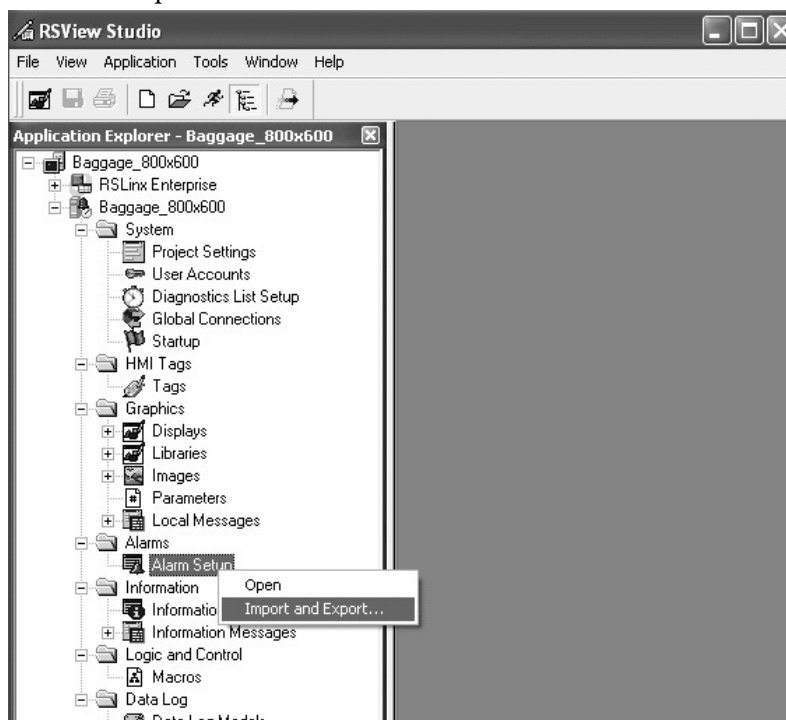

3. Select Export alarm configuration from application and click Next.

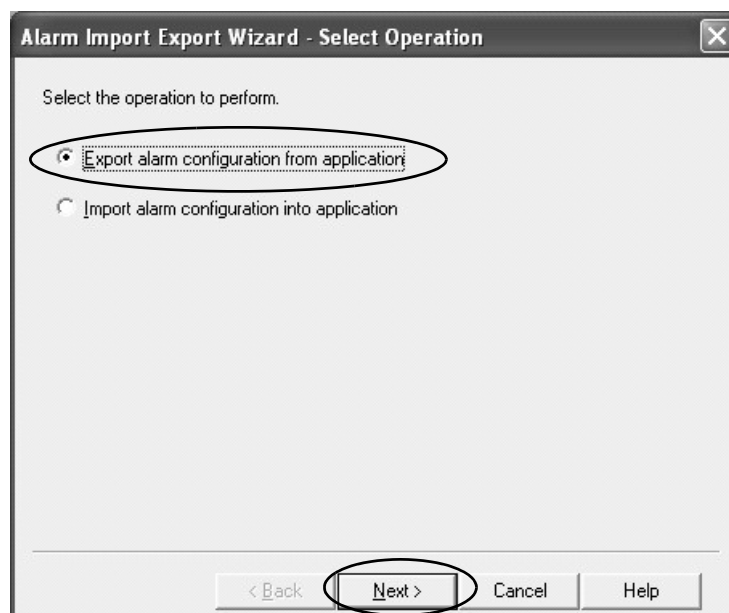

4. Accept the default file name Alarms and click Finish.

The alarms have been successfully exported to the alarms.xml file.

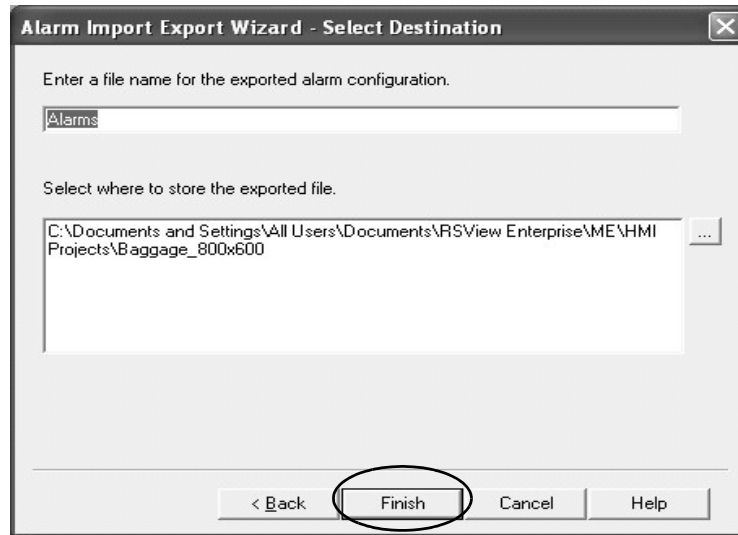

The default location for the alarm.xml file is:

C:\Documents and Settings\All Users\Documents\RSView Enterprise\ME\HMI Projects\Project_Name\Alarms.xml

Run the Tag Converter Wizard

Now that you have completed the pre-conversion process, you are ready to run the tag converter wizard. The executable file is named TCW.exe.

TIP The original HMI tag database is not altered.

During the conversion, most of the tags are converted to direct reference tags. You will have to manually set scale and offset values for tags after the conversion.

1. Double-click the TCW.exe utility.

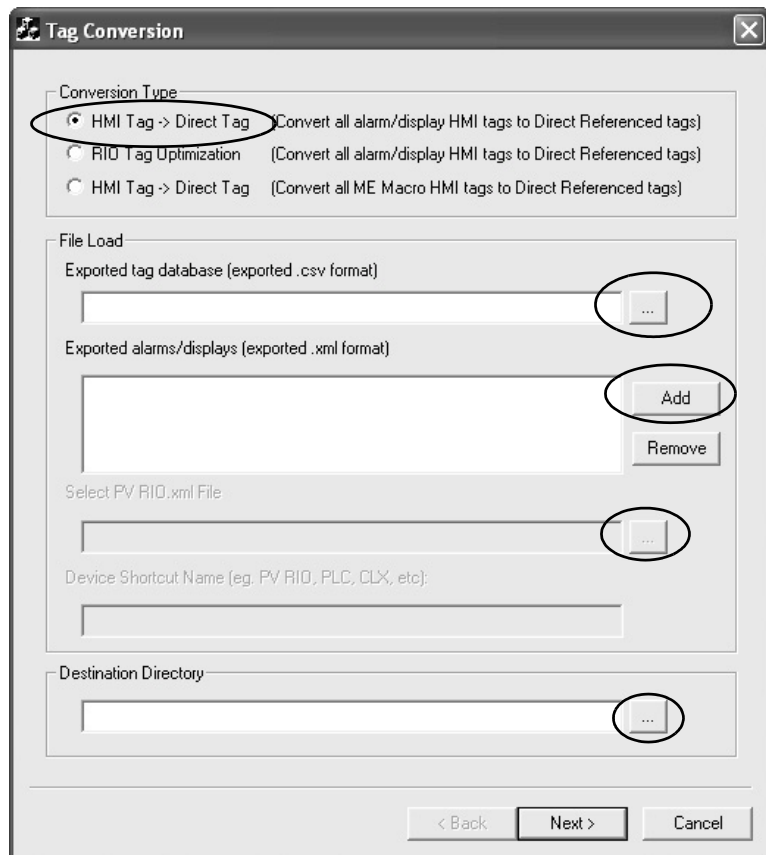

2. Select the HMI Tag ->Direct Tag conversion type.
3. Click the ... button next to the Exported Tag Database field and load the exported tag database.

The file is located in the directory that is specified in step 6 on page 95.

4. Click the Add button next to Exported alarms/displays.
5. Load the exported alarms and display xml files.

The alarms file is located in the folder that is specified under step 4 on page 102.

The xml display files are located in the folder that is specified in step 6 on page 28.

Hold down the Shift key and select all displays to load all displays at once.

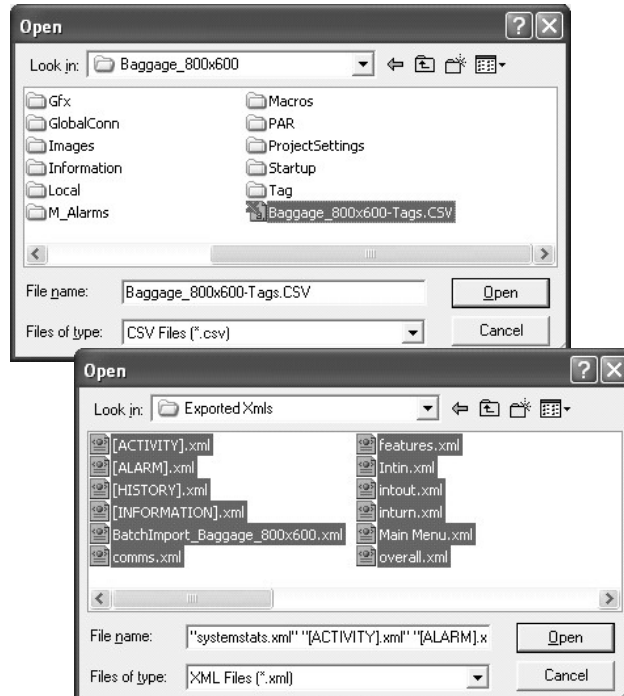

6. In the Destination Directory field, click the ... button to specify any location for the new xml display files.

The example that is shown may look different depending on the network protocol of your application.

7. Click Next to continue the conversion.

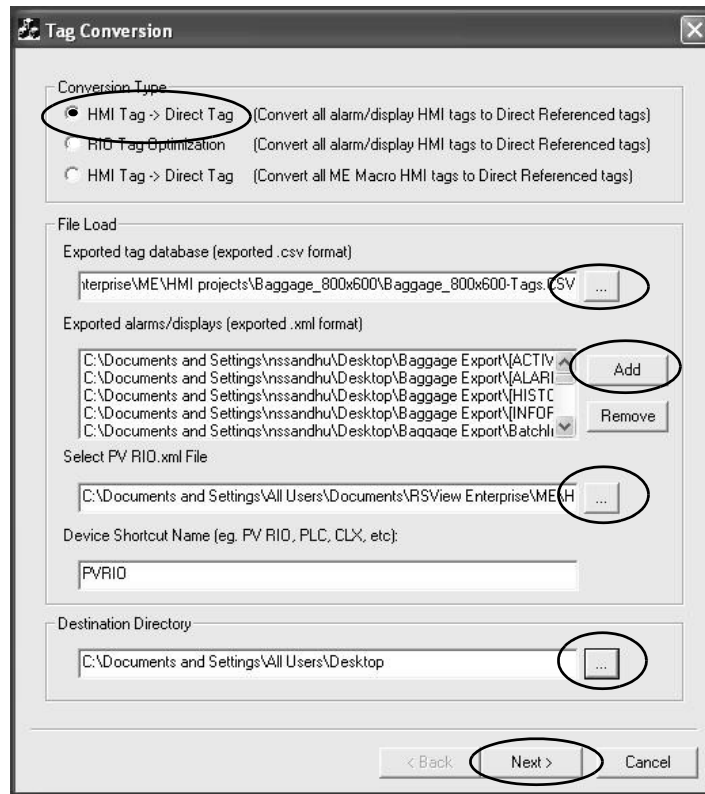

The Report dialog box shows the number of tag and display substitutions made.

8. Click Finish.

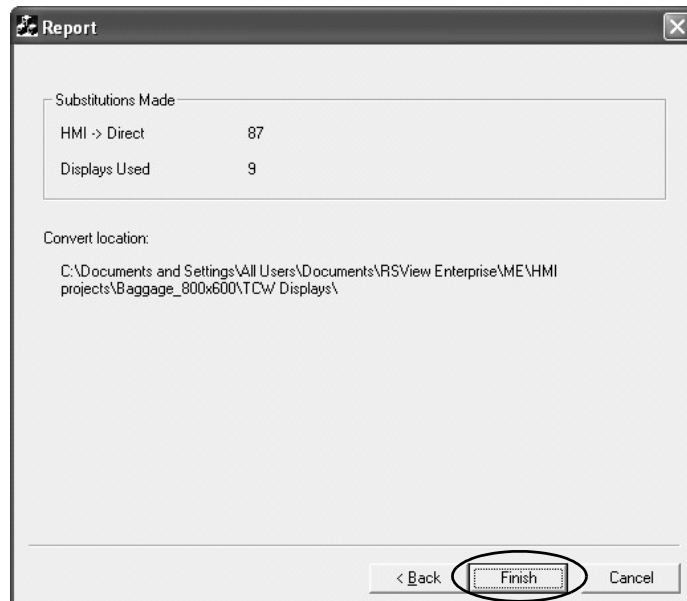

A conversion log file, Conversion_Log.txt, is created and stored with the converted xml files.

The conversion process is complete. The utility has successfully converted all HMI device tags to alias or direct reference tags in all displays.

```

convert_log.txt - Notepad
File Edit Format View Help
Converting the source file C:\Documents and Settings\All
Users\Documents\RSView Enterprise\ME\HMI projects\Baggage_800x600\Alarms.xml
to C:\Documents and Settings\All Users\Documents\RSView Enterprise\ME\HMI
projects\Baggage_800x600\TCW Displays\Alarms.xml

HMI Tag: {outbound\motor_fault} was substituted with Direct Referenced Tag:
{::[Baggage]N7:15}
HMI Tag: {outbound\pusher7_fault} was substituted with Direct Referenced Tag:
{::[Baggage]N7:10}
HMI Tag: {outbound\cab1_fault} was substituted with Direct Referenced Tag:
{::[Baggage]N7:7}
HMI Tag: {outbound\induct1_fault} was substituted with Direct Referenced Tag:
{::[Baggage]N7:23}
HMI Tag: {outbound\dom_to_int_jam} was substituted with Direct Referenced
Tag: {::[Baggage]N7:16}
HMI Tag: {outbound\pier4_jam} was substituted with Direct Referenced Tag:
{::[Baggage]N7:8}
Converted count: 6

Converting the source file C:\Documents and Settings\All
Users\Documents\RSView Enterprise\ME\HMI projects\Baggage_800x600\TCW
Displays\[ACTIVITY].xml to C:\Documents and Settings\All
Users\Documents\RSView Enterprise\ME\HMI projects\Baggage_800x600\TCW
Displays\[ACTIVITY].xml

Converting the source file C:\Documents and Settings\All
Users\Documents\RSView Enterprise\ME\HMI projects\Baggage_800x600\TCW
Displays\[ALARM].xml to C:\Documents and Settings\All Users\Documents\RSView
Enterprise\ME\HMI projects\Baggage_800x600\TCW Displays\[ALARM].xml

Converting the source file C:\Documents and Settings\All
Users\Documents\RSView Enterprise\ME\HMI projects\Baggage_800x600\TCW
Displays\[HISTORY].xml to C:\Documents and Settings\All

```

In addition to the conversion log file, the tag converter wizard generates a tag cross-reference .csv file in the destination folder. This file cross-references HMI tags to alias and direct reference tags.

When you open the .csv file in Excel, three columns show how the tags are linked.

HMI Tag	Alias Tag	Direct Reference Tag
Tag1	MotorSart1	N7:0

Reimport the Display XML File

Now that you have converted all alarms and displays, you are ready to reimport the information into your application.

IMPORTANT Manually copy the BatchImport_Your_Project_Name.xml file to the location of the new displays that are created by the TCW utility. Select the xml file from this folder so all new displays are imported, not the original, unmodified displays.

Follow these steps to reimport the xml display files to your application.

1. Navigate back to the open instance of the FactoryTalk View Studio software.
2. In the Application Explorer, right-click Displays and choose Import and Export.

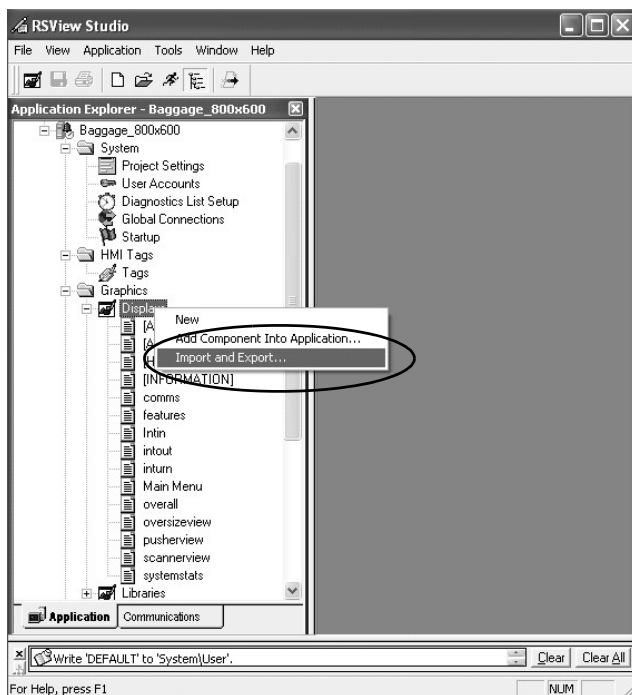

3. Select Import graphic information into displays and click Next.

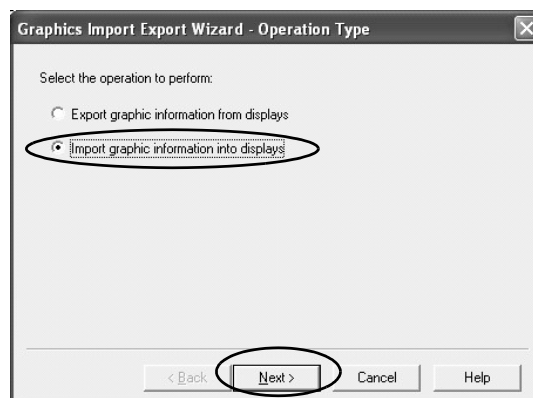

4. Select No to not back up the displays.

You completed this action when you exported graphic displays to xml format on page 97.

5. Click Next.

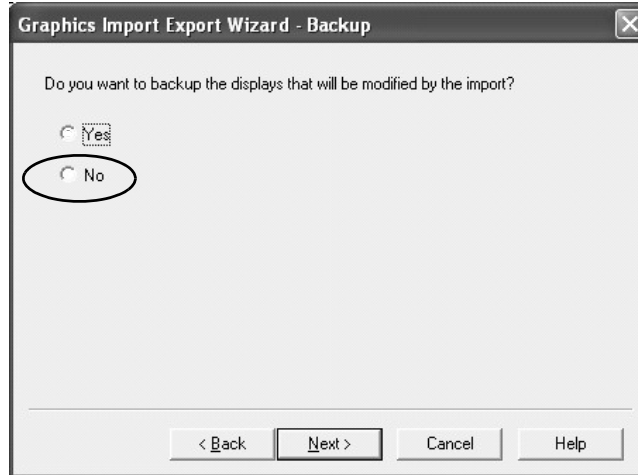

6. Select Multiple displays batch import file and click Next.



7. Click the ... button.



8. Select and open the BatchImport_Your_Project_Name.xml

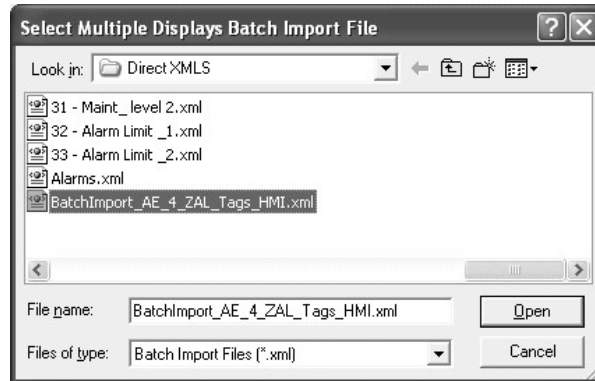

9. Select Update existing objects on the display.

10. Click Finish.

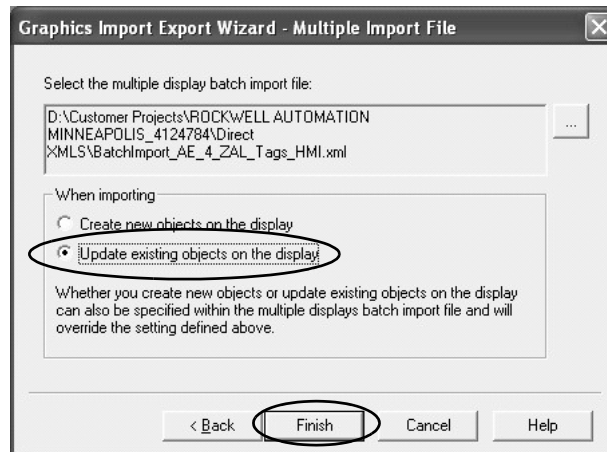

11. Review the DisplaysImport.txt file for errors.

The new alias and direct reference tags have been successfully imported into the application.

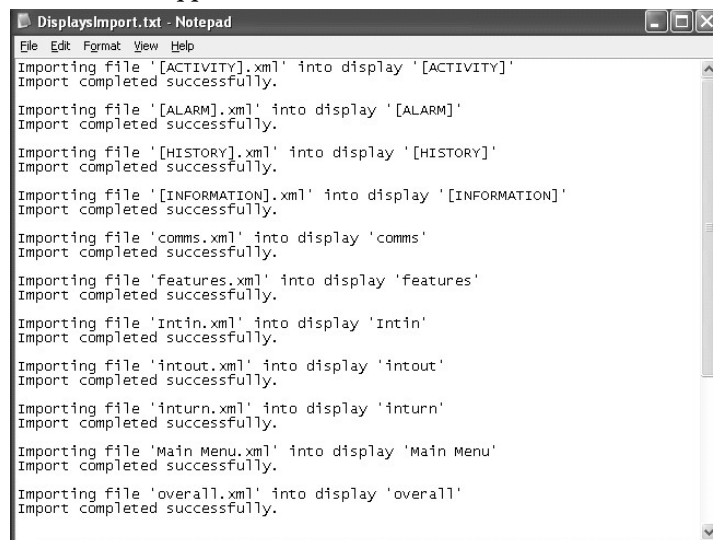

Reimport the Alarms XML File

Follow these steps to reimport the xml alarms file to your application.

1. Navigate back to the open instance of the FactoryTalk View Studio software.
2. In the Application Explorer, right-click Alarm Setup and choose Import and Export.

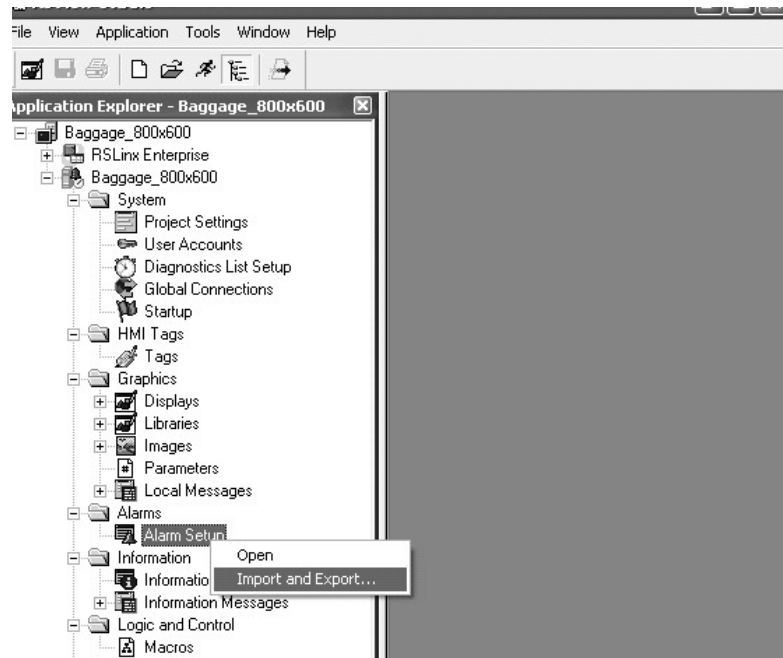

3. Select No to not back up the alarms.
4. Click Next.



5. To select the Alarms.xml file from created by the TCW utility, click the ... button.

6. Click Finish.

The project has been successfully updated with the new alarms.

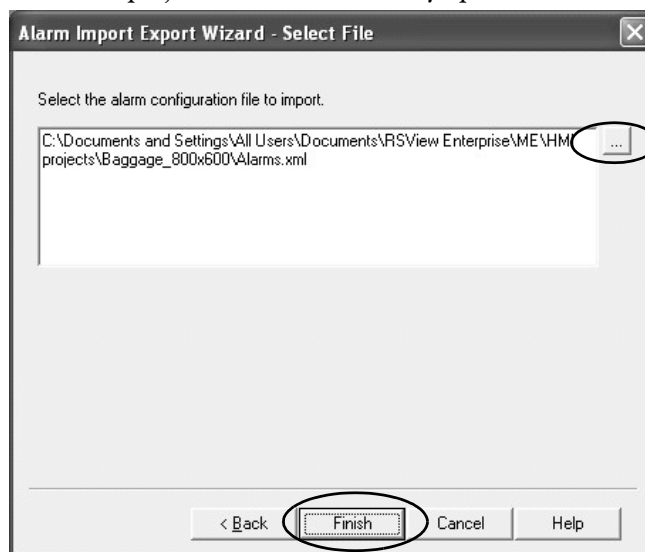

You can now retest your application for optimized performance.

Notes:

Advanced Object Editing

Introduction

Editing techniques can save you time when using FactoryTalk® View Studio software. Use these techniques to reduce the migration effort when updating common properties between multiple graphic objects:

- Property panel
- Editing multiple objects
- Object explorer
- Tag substitution

Property Panel

The property panel is a powerful editing tool that you can use to perform quick edits and tag assignments by simply clicking a graphic object. You can modify the property values of graphic objects, and assign tags and expressions to objects. Any edits that you make in the property panel are applied immediately.

Follow these steps to open the property panel.

1. With a graphic display open, choose View>Property Panel.

The property panel may not contain any information in it. This status is the result of not selecting an object.

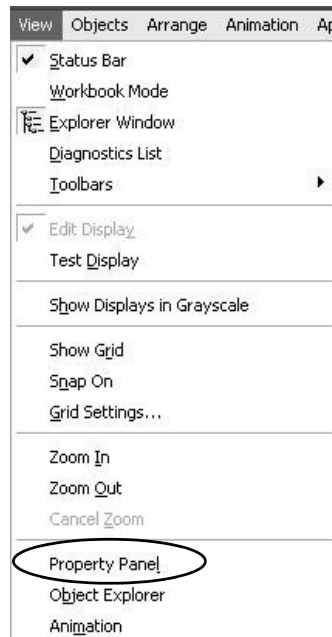

2. Select a graphic object on the display.

This example shows a text object selected. The property panel shows all properties that you can edit for the selected object.

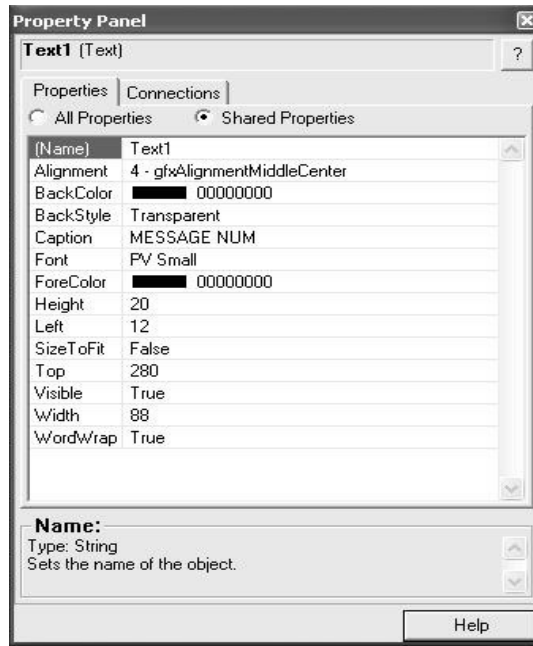

3. To view and edit the tag connection properties for the selected object, select the Connections tab.

This example shows the Value and Polarity connections for a numeric display object.

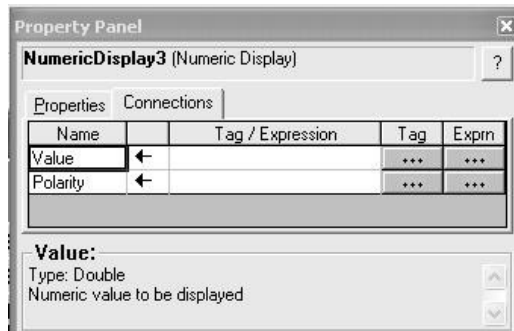

Edit Multiple Objects

One of the most useful features of the property panel is that you can edit multiple graphic objects with common properties simultaneously, rather than editing each object, one by one.

Chapter 6, Review Unsupported Features, showed you how to create replacement multistate indicator, local message and numeric data display list objects in FactoryTalk View ME software. Creating this replacement graphic objects also required you to update properties to match the original PanelBuilder[®]32 objects. These properties included captions, foreground/background colors, text size, number of states, and more.

Follow these steps to change a few properties for a group of ten multistate indicator objects.

1. Select a group of graphic objects you want to edit.

If your objects are not grouped, simply hold down the Ctrl key and click each object.

When a set of grouped objects are selected, the property panel shows only the grouped properties.

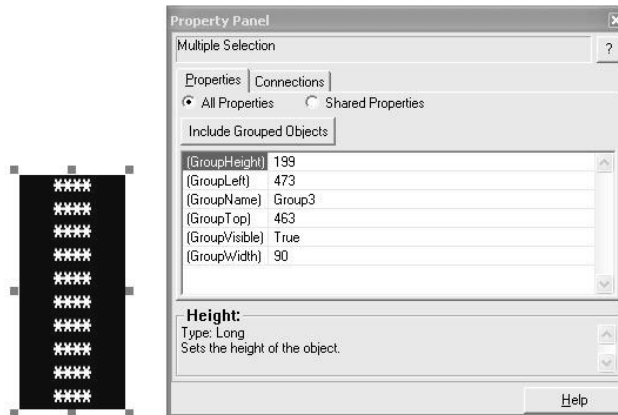

- Click the Include Grouped Objects button on the property panel.
You see all properties that can be edited for the objects in the group.

Clicking any property provides a popup, pull-down menu, or other editing method.

In the next step, you will change the ST_Caption from **** to State 0 and the ST_BackColor to Green. These changes are then applied to all selected objects for the state that is defined in the State property.

To change other states, simply change the State property to State1 and make the desired edits.

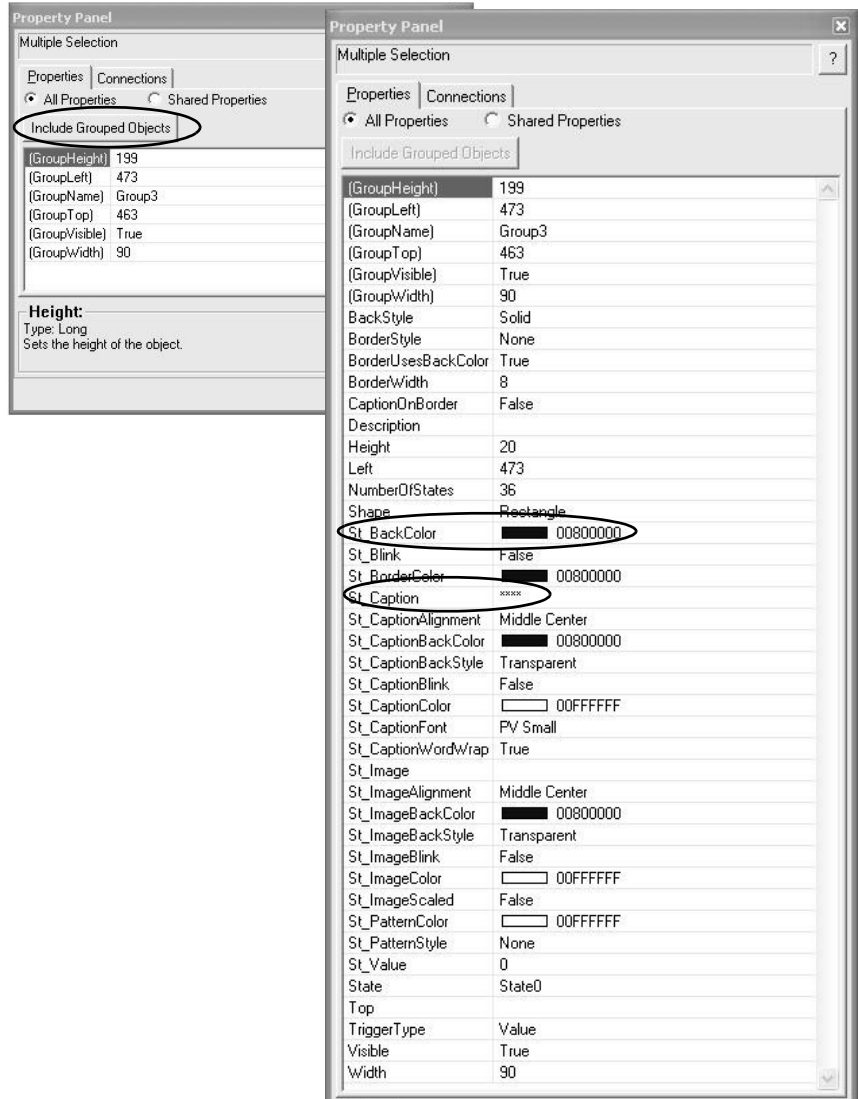

- Click the ... button next to St_Caption.

4. Type the new caption in the String Edit dialog box and click OK.

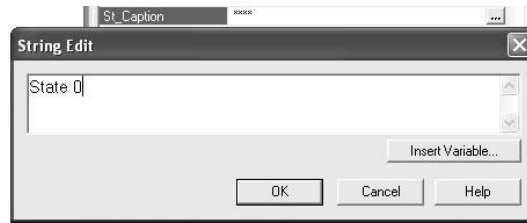

5. Click the ... button in the St_BackColor field.
6. In the color palette that opens, click a new color.

The example shows the grouped objects before and after edits.

Depending on the object you are editing, the properties differ. Help text at the bottom identifies what the property does.

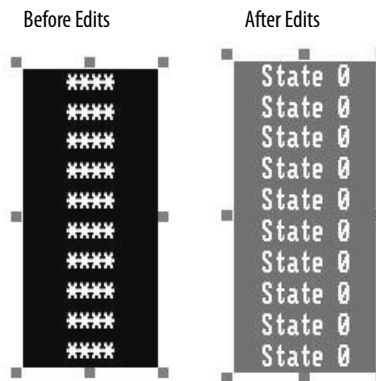

TIP You can apply this editing technique to cursor llist objects, depending on the number of objects. This action saves you time when updating your objects in FactoryTalk View ME software to match the original PanelBuilder32 object.

Object Explorer

The object explorer provides a tree-list of all objects in the selected display. You can select and highlight objects in this list.

Groups are listed as expandable items, with the + icon. To view the objects in a group, click the + icon or double-click the group name. The list expands to show the objects and groups within a group.

You can use the highlight settings to highlight specified objects on both the graphic display and object explorer. You can select objects by object type, by animation type, or by tag name.

For a display with many objects, object explorer provides an efficient way of locating and selecting graphic objects. If you want to edit specific objects, object explorer can highlight these objects for you. By using the property panel, you can do one the following:

- Perform multiple edits instantly

- Double-click the object in object explorer to open the properties dialog box and make edits to a single object

Follow these steps to open object explorer.

1. With a graphic display open, choose View>Object Explorer.
2. Expand or collapse groups of objects by clicking the Expand or Collapse buttons.

The objects that appear in the list differ for each display.

3. To search for objects, click the Settings button.



The Highlight Settings dialog box allows you to search for objects by Object Type, Animation Type, or Tag Name.

When selecting by tag name, the list shows all tags and expressions that are referenced by objects in the display, except tags with embedded variables.

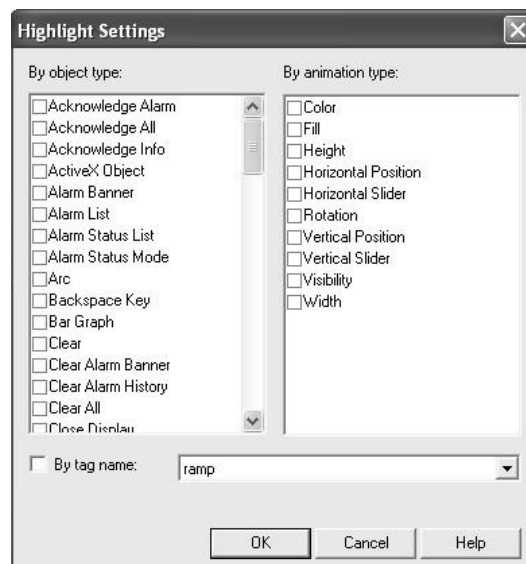

4. Select Local Message Objects to search for all local message objects.

5. Click OK to return to the object explorer.

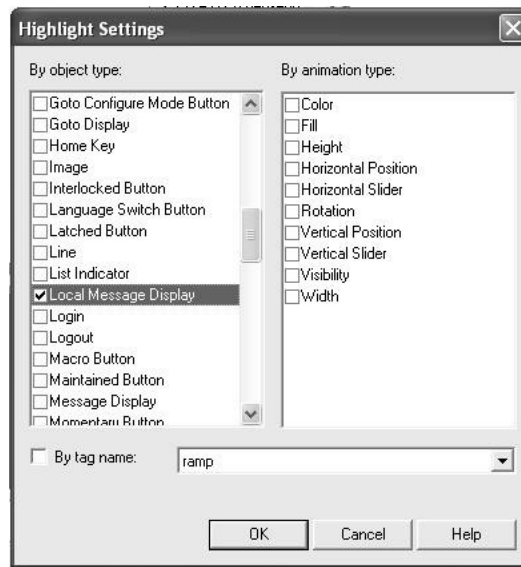

6. Check the Highlighting on checkbox and click the Expand button.



The object explorer highlights all local message displays in red.

Local message objects on the display also appear red with a border.

If you have a display with a red background, the red highlights are not visible.

When you select an object in the object explorer, the Highlight mode turns off. Simply, recheck the Highlight on box to turn the highlights back on.

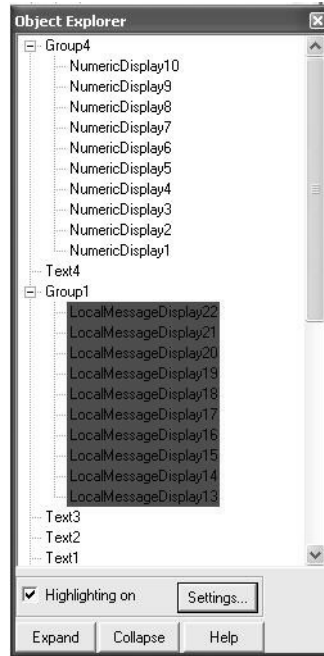

Display Object

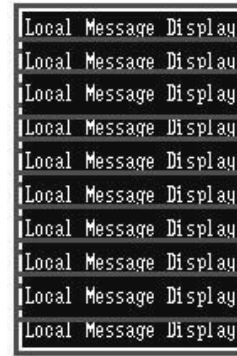

7. To open the properties for the local message display, double-click an object in the object explorer.
8. Edit the properties and click OK.

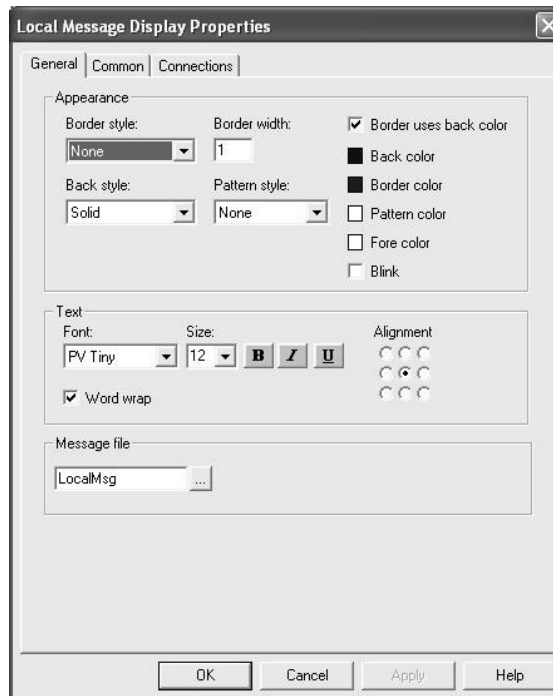

If the property panel and object explorer are both open, click any object in object explorer. The property panel updates the display with the edit properties for the selected objects. You can make any updates from the property panel.

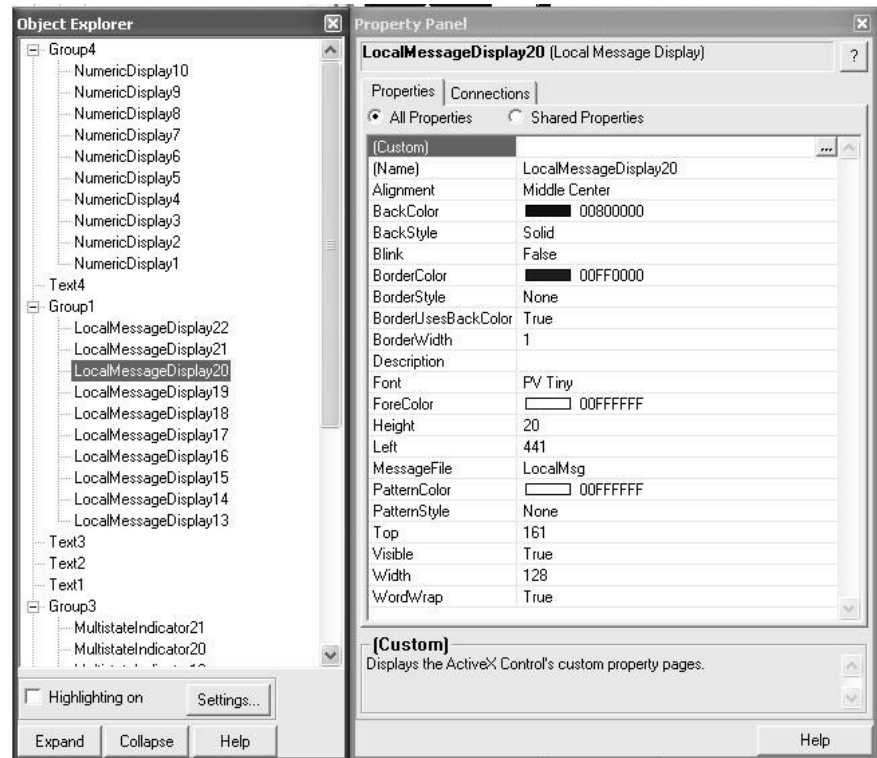

Substitute Tags

You can use tag substitution to replace tag names or character strings in all selected graphic objects on a display. Character strings include tag placeholders, expressions, and parts of strings within expressions. When replacing tags, you can use an entire tag name, including folders, or you can replace a string of characters.

TIP You cannot use wildcard characters when searching for or replacing tag names.

Tag substitution is useful when your graphic displays use a direct reference tag name or if an HMI Tag name is referenced throughout your application and must be updated.

Follow these steps to substitute a tag or character string.

1. Open the graphic display that you want to update.
2. To select all objects in the display, press Ctrl-A.

All objects on the display are highlighted. This example display is for illustration purposes only.

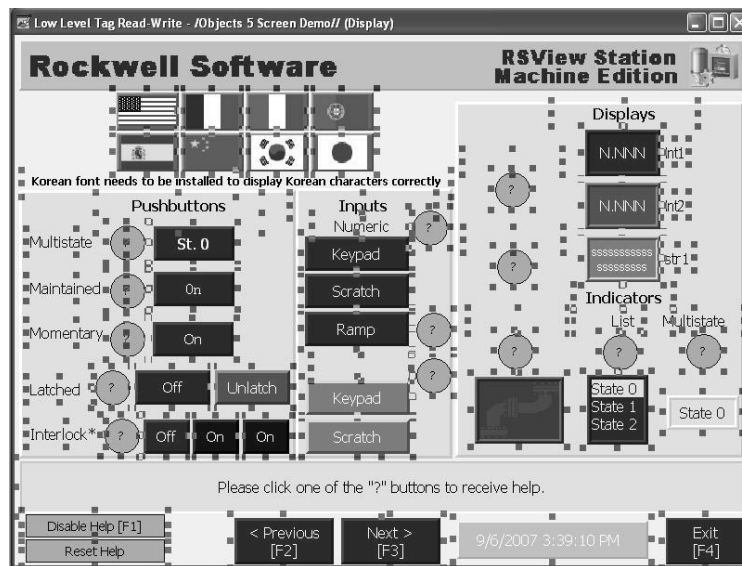

TIP You must select all objects or the Tag Substitution dialog box only shows tags of the selected objects.

3. Choose Edit>Tag Substitution.

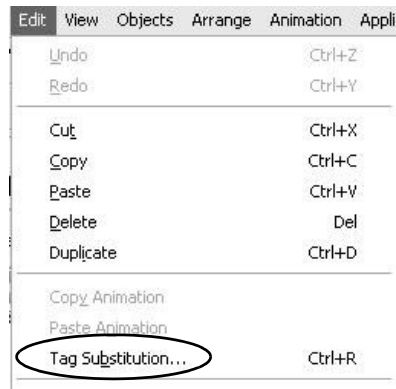

In the Tag Substitution editor, you can search on an existing name or a part of a tag name.

4. Type mem in the Search for box.
5. Type tag in the Replace with box.

Uncheck the Confirm Replacement option, if you don't want to confirm every replacement.

6. Click Replace.

The editor searches for each tag that contains the partial string mem and replaces the string with tag. You are prompted to confirm each replacement.

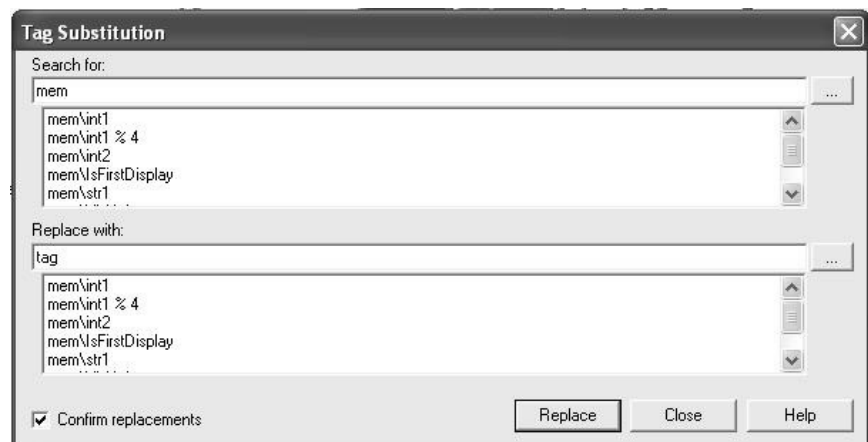

7. Click Replace All to confirm the replacement of all tags at once.

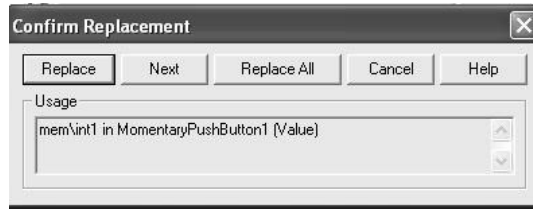

You are notified when the substitution is complete.

8. Click OK.



9. To verify that tags with the string mem were updated to tag, choose Edit>Tag Substitution.

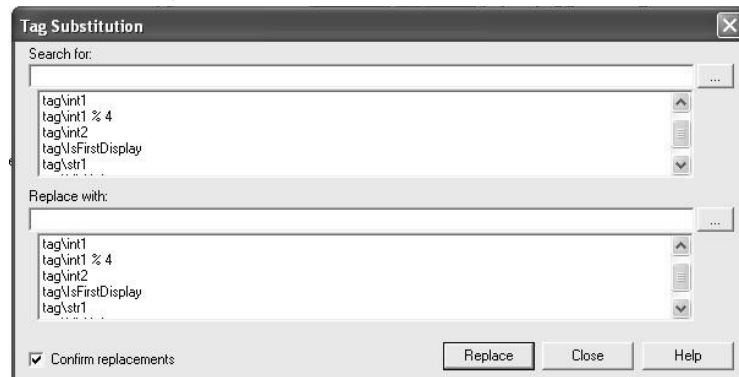

You can use tag substitution on a display-by-display basis to verify that all tags or partial strings are updated correctly in the application.

A

adapter plates 18
alarms 98

B

background updates 97

C

communication
 configuring 71
CompactFlash card downloads 84
conversion
 tips 52
conversion log 54
 alarm conversion messages 59
 messages 56
 opening 54
 reviewing 54
 RSLinx messages 56
 screen and object messages 57
 tag conversion messages 59

D

data type mapping 62
diagnostic list 70
download runtime application
 Ethernet connection 84
 external storage device 88

E

editing multiple objects 120
error states for objects 70, 71, 73
export
 alarms to xml file 107
 graphic displays to xml file 103
 hmi tag database 100

F

FactoryTalk View ME software
 conversion log 54
 diagnostic list 70
 editing multiple objects 120
 editing objects 119
 error states 73
 import application 48
 object explorer 123
 property panel 119
 tag substitution 128
 test run displays 76
 unsupported features 66

G

global memory connections 79

I

import
 alarm xml file 116
 display xml file 112
importing application 48
 communication mapping 63
 conversion log 54
 data type mapping 62
 object mapping 62

M

mapping
 communication protocols 63
 data types 62
 objects 62
migrated application
 ControlNet communication 76
 create runtime application 83
 DH+ communication 74
 diagnostic list 70
 download runtime application 84
 run application 91
 test run 76, 79
 test run displays 76
 unsupported features 66
migration considerations 11

O

object editing
 multiple objects 120
 object explorer 123
 property panel 119
 tag substitution 128
object explorer 123, 128
object mapping 62

P

performance
 background updates 97
 converting tags 99
 measuring 96
 optimize tags 98
post conversion tips 52
property panel 119

R

run application 84, 91
runtime application
 create 83
 download 84
runtime diagnostic display
 configure 71

T

- tag converter wizard** 99
 - run 109
- tag substitution** 128
- terminal replacements** 18
- test run**
 - application 79
 - displays 76

U

- unsupported features** 66
 - objects 66

Additional Resources

These documents contain additional information concerning related products from Rockwell Automation.

Resource	Description
Adapter Kit for PanelView 5500 and PanelView Plus 7 Performance Terminals Installation Instructions, publication VIEW-IN002	Provides information on how to install a PanelView Plus 7 terminal into an existing cutout from a PanelView Standard terminal.
Legacy PanelView Terminals to PanelView Plus 7 Terminals Catalog Number Conversions Migration Guide, publication 2711P-AP005	Provides information on how to convert legacy 2711 PanelView Standard terminals and 2711E PanelView Enhanced terminals to the new generation terminals: PanelView Plus 7 Standard terminals and PanelView Plus 7 Performance terminals.
PanelView Plus 7 Performance Terminals User Manual, publication 2711P-UM008	Provides information on how to install, operate, configure, and troubleshoot PanelView Plus 7 performance terminals.
PanelView Plus 7 Standard Terminals User Manual, publication 2711P-UM007	Provides information on how to install, operate, configure, and troubleshoot PanelView Plus 7 standard terminals.
Visualization Solutions Selection Guide, publication VIEW-SG001	Provides an overview of visualization products, including PanelView Plus 7 terminals.
FactoryTalk View Studio online help	Provides information and procedures on how to create FactoryTalk View Machine Edition applications and supported features.
Industrial Automation Wiring and Grounding Guidelines, publication 1770-4.1	Provides general guidelines on how to install a Rockwell Automation industrial system.
Product Certifications website, rok.auto/certifications	Provides declarations of conformity, certificates, and other certification details.

You can view or download publications at rok.auto/literature.

Rockwell Automation Support

Use these resources to access support information.

Technical Support Center	Find help with how-to videos, FAQs, chat, user forums, and product notification updates.	rok.auto/support
Knowledgebase	Access Knowledgebase articles.	rok.auto/knowledgebase
Local Technical Support Phone Numbers	Locate the telephone number for your country.	rok.auto/phonesupport
Literature Library	Find installation instructions, manuals, brochures, and technical data publications.	rok.auto/literature
Product Compatibility and Download Center (PCDC)	Download firmware, associated files (such as AOP, EDS, and DTM), and access product release notes.	rok.auto/pcdc

Documentation Feedback

Your comments help us serve your documentation needs better. If you have any suggestions on how to improve our content, complete the form at rok.auto/docfeedback.

Waste Electrical and Electronic Equipment (WEEE)



At the end of life, this equipment should be collected separately from any unsorted municipal waste.





Rockwell Automation maintains current product environmental compliance information on its website at rok.auto/pec.

Allen-Bradley, AutoMax, ControlLogix, DH+, Encompass, expanding human possibility, FactoryTalk, Logix5000, PanelBuilder, PanelView, PLC-5, Rockwell Automation, RSLinx, RSVIEW, and SLC are trademarks of Rockwell Automation, Inc.

EtherNet/IP is a trademark of ODVA, Inc.

Trademarks not belonging to Rockwell Automation are property of their respective companies.

Rockwell Otomasyon Ticaret A.Ş. Kar Plaza İş Merkezi E Blok Kat:6 34752, İçerenköy, İstanbul, Tel: +90 (216) 5698400 EEE Yönetmeliğine Uygundur

Connect with us.    

rockwellautomation.com ————— expanding **human possibility**[®]

AMERICAS: Rockwell Automation, 1201 South Second Street, Milwaukee, WI 53204-2496 USA, Tel: (1) 414.382.2000, Fax: (1) 414.382.4444

EUROPE/MIDDLE EAST/AFRICA: Rockwell Automation NV, Pegasus Park, De Kleetlaan 12a, 1831 Diegem, Belgium, Tel: (32) 2 663 0600, Fax: (32) 2 663 0640

ASIA PACIFIC: Rockwell Automation, Level 14, Core F, Cyberport 3, 100 Cyberport Road, Hong Kong, Tel: (852) 2887 4788, Fax: (852) 2508 1846

Publication 2711P-AP006E-EN-P - August 2022

2711P-AP006D-EN-P - March 2021

Copyright © 2022 Rockwell Automation, Inc. All rights reserved. Printed in the U.S.A.