

# SIEMENS

Zubehör für Kompaktleistungsschalter 3VT  
 Accessory for Molded-Case Circuit Breakers 3VT  
 Accessoires de disjoncteurs compacts 3VT  
 Accesorios para interruptores compactos 3VT  
 Accessori per interruptori compatti 3VT  
 Acessórios para disjuntores compactos 3VT  
 Kompakt güç şalteri 3VT aksesuarı  
 Принадлежности к компактному силовому выключателю 3VT  
 3VT 塑料外壳式断路器附件

3VT9224-4TD30  
 3VT9224-4TD00  
 3VT9215-4TF30  
 3VT9215-4TF00

EN 60947-1  
 EN 60947-2



DE	Zubehör für Kompaktleistungsschalter 3VT, 3 und 4-polig
	<b>Rundleiteranschlussklemme</b> Betriebsanleitung
EN	Accessory for 3 and 4-pole Molded-Case Circuit Breakers 3VT
	<b>Circular conductor terminal</b> Operating Instructions
FR	Accessoires de disjoncteurs compacts 3VT, à 3 et 4 pôles
	<b>Borne pour conducteurs ronds</b> Instructions de service
ES	Accesorios para interruptores compactos 3VT, de 3 y 4 polos
	<b>Borne para sección redonda</b> Instructivo
IT	Accessori per interruptori compatti 3VT, a 3 e a 4 poli
	<b>Morsetto di collegamento per conduttore circolare</b> Istruzioni operative
PT	Acessórios para disjuntores compactos 3VT tripolares e tetrapolares
	<b>Terminal para condutor de seção circular</b> Instruções de Serviço
TR	Kompakt güç şalteri 3VT aksesuarı, 3 ve 4 kutuplu
	<b>Dairesel iletken bağlantı klemensi</b> İşletme kılavuzu
PY	Принадлежности к компактному силовому выключателю 3VT, 3- и 4-полюсному
	<b>Соединительная клемма провода круглого сечения</b> Инструкция по эксплуатации
中文	3VT 塑料外壳式断路器附件, 3 极和 4 极
	<b>圆形导线连接端子</b> 操作规程

3VT9224-4TD30  
 3VT9215-4TF30

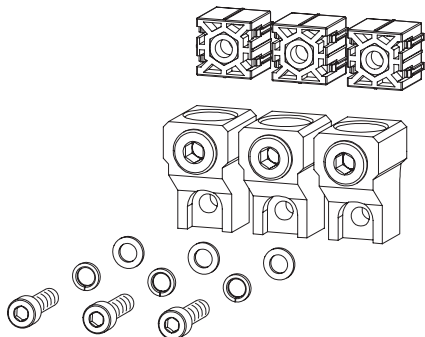



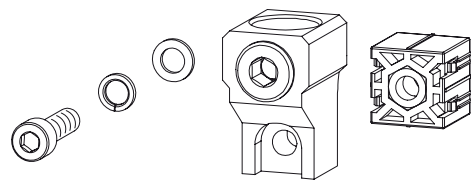



3VT9224-4TD00  
 3VT9215-4TF00



**Technical Assistance:** Telephone: +49 (0) 911-895-5900 (8°° - 17°° CET)  
 E-mail: [technical-assistance@siemens.com](mailto:technical-assistance@siemens.com)  
 Internet: [www.siemens.de/lowvoltage/technical-assistance](http://www.siemens.de/lowvoltage/technical-assistance)

**Technical Support:** Telephone: +49 (0) 180 50 50 222

Fax: +49 (0) 911-895-5907

	Deutsch	English	Français
	<p>Vor der Installation, dem Betrieb oder der Wartung des Geräts muss diese Anleitung gelesen und verstanden werden.</p> <p>Eine sichere Gerätefunktion ist nur mit zertifizierten Komponenten gewährleistet!</p>	<p>Read and understand these instructions before installing, operating, or maintaining the equipment.</p> <p>Reliable functioning of the equipment is only ensured with certified components.</p>	<p>Ne pas installer, utiliser ou intervenir sur cet équipement avant d'avoir lu et assimilé les présentes instructions et notamment les conseils de sécurité et mises en garde qui y figurent.</p> <p>La sécurité de fonctionnement de l'appareil n'est garantie qu'avec des composants certifiés.</p>
	<b>⚠ GEFAHR</b>	<b>⚠ DANGER</b>	<b>⚠ DANGER</b>
 	<p><b>Gefährliche Spannung. Lebensgefahr oder schwere Verletzungsgefahr.</b></p> <p>Vor Beginn der Arbeiten Anlage und Gerät spannungsfrei schalten.</p>	<p><b>Hazardous voltage. Will cause death or serious injury.</b></p> <p>Turn off and lock out all power supplying this device before working on this device.</p>	<p><b>Tension électrique. Danger de mort ou risque de blessures graves.</b></p> <p>Mettre hors tension avant d'intervenir sur l'appareil.</p>
	Español	Italiano	Português
	<p>Leer y comprender este instructivo antes de la instalación, operación o mantenimiento del equipo.</p> <p>El funcionamiento seguro del aparato sólo está garantizado con componentes certificados.</p>	<p>Leggere con attenzione queste istruzioni prima di installare, utilizzare o eseguire manutenzione su questa apparecchiatura.</p> <p>Il funzionamento sicuro dell'apparecchiatura è garantito soltanto con componenti certificati.</p>	<p>Ler e compreender estas instruções antes da instalação, operação ou manutenção do equipamento.</p> <p>O funcionamento seguro do aparelho apenas pode ser garantido se forem utilizados os componentes certificados.</p>
	<b>⚠ PELIGRO</b>	<b>⚠ PERICOLO</b>	<b>⚠ PERIGO</b>
 	<p><b>Tensión peligrosa. Puede causar la muerte o lesiones graves.</b></p> <p>Desconectar la alimentación eléctrica antes de trabajar en el equipo.</p>	<p><b>Tensione pericolosa. Può provocare morte o lesioni gravi.</b></p> <p>Scollegare l'alimentazione prima di eseguire interventi sull'apparecchiatura.</p>	<p><b>Tensão perigosa. Perigo de morte ou ferimentos graves.</b></p> <p>Desligue a corrente antes de trabalhar no equipamento.</p>
	Türkçe	Русский	中文
	<p>Cihazın kurulumundan, çalıştırılmasından veya bakıma tabi tutulmasından önce, bu kılavuzun okunmuş ve anlaşılması gerekmektedir.</p> <p>Cihazın güvenli çalışması ancak sertifikalı bileşenler kullanılması halinde garanti edilebilir.</p>	<p>Перед установкой, вводом в эксплуатацию или обслуживанием устройства необходимо прочесть и понять данное руководство.</p> <p>Безопасность работы устройства гарантировано только при использовании сертифицированных компонентов.</p>	<p>安装、使用和维修本设备前必须先阅读并理解本说明。</p> <p>只有使用经过认证的部件才能保证设备的正常运转！</p>
	<b>⚠ TEHLİKE</b>	<b>⚠ ОПАСНО</b>	<b>⚠ 危險</b>
 	<p><b>Tehlikeli gerilim. Ölüm tehlikesi veya ağır yaralanma tehlikesi mevcuttur.</b></p> <p>Çalışmalara başlamadan önce, sistemin ve cihazın enerjisini kesiniz.</p>	<p><b>Опасное напряжение. Опасность для жизни или возможность тяжелых травм.</b></p> <p>Перед началом работ отключить подачу питания к установке и к устройству.</p>	<p><b>危險电压。可能导致生命危险或重伤危险。</b></p> <p>操作设备时必须确保切断电源。</p>

DE	Lieferumfang
EN	Quantity of delivery
FR	Composition de la fourniture
ES	Alcance del suministro
IT	Configurazione di fornitura
PT	Escopo de fornecimento
TR	Teslimat hacmi
PY	Комплект поставки
中文	供货范围

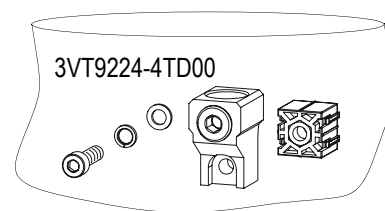
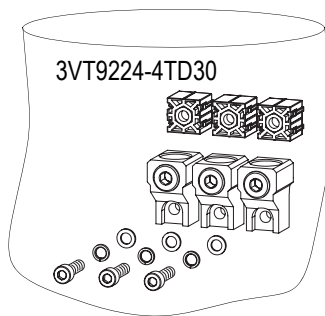

DE	Notwendige Werkzeuge für Montage
EN	Necessary assembly tools
FR	Outils nécessaires pour le montage
ES	Herramientas requeridas para el montaje
IT	Utensili necessari per il montaggio
PT	Ferramentas necessárias para a montagem
TR	Montaj için gerekli aletler
PY	Инструменты, необходимые для монтажа
中文	安装所需工具

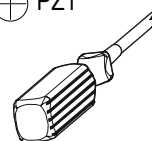
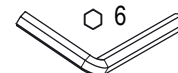
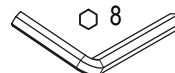
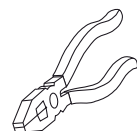

cal. ISO 6789

DE	<b>Montage</b>	EN	<b>Assembly</b>	FR	<b>Montage</b>
ES	<b>Montaje</b>	IT	<b>Montaggio</b>	PT	<b>Montagem</b>
TR	<b>Montaj</b>	PY	<b>Монтаж</b>	中文	<b>安装</b>

